

TESTS OF A 3D PRINTED BPM WITH A STRETCHED WIRE AND WITH A PARTICLE BEAM *

N. Delerue[†], D. Auguste, J. Bonis, F. Gauthier, S. Jenzer, and A. Moutardier, LAL, Univ. Paris-Sud, CNRS/IN2P3, Université Paris-Saclay, Orsay, France.

Abstract

We have successfully printed a beam position monitor using 3D printing. After ultra-high vacuum testing and initial measurements with a network analyser we now reports on tests of this BPM using the stretched wire method. The BPM has been installed on a test stand with a wire going through it and electrical pulses have been sent. The signal measured on the pick-ups was compared to that of two conventional BPMs and shows no anomaly specific to the 3D printed BPMs. Following the success of these tests we have also installed this BPM in a beam line at the PhotoInjector at LAL (PHIL). We show that it can give position measurements with an accuracy comparable to that of other BPMs.

INTRODUCTION

During the past few years we have been investigating the potential of metal additive manufacturing (metal 3D printing) for particle accelerator. We have first demonstrated that part produced using Selective Laser Melting (SLM - one of the main additive manufacturing technique for metals) can be compatible with the requirements of Ultra-High Vacuum (see [1]). Additional studies related to the use of additive manufacturing for UHV beam pipes are discussed this year in another paper [2]. More recently we have produced a beam position monitor and tested it with the Lambertson method [3]. We have now taken the tests of this BPM two steps further, first by testing it on a test bench with the stretched wire method and this is discussed in the next section and then by installing it in an accelerator to study its behaviour with a real beam and this is discussed in the last section.

The BPM used for the tests described in the paper has been printed using Selective Laser Melting. The powder used to print it was 316L powder. Its design is based on the design of conventional BPMs that have produced for another project in our lab. However the design has been optimized using topological optimization as described in [3]. A CAD drawing of the BPM as well as pictures can be seen on figure 1.

After additive manufacturing minor work was still required in the workshop to sharpen the vacuum knife-edges and to solder the electrical feedthrough (which were not made by additive manufacturing). This BPM was about 50% cheaper than a BPM machined in the mechanical workshop and conventional one it took two weeks to build against 6 weeks with conventional tools. For the same fonctionnali-

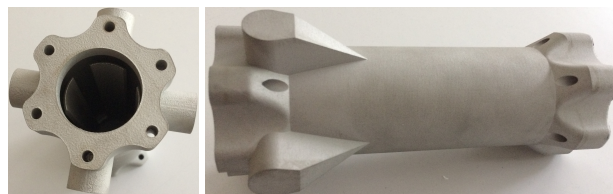
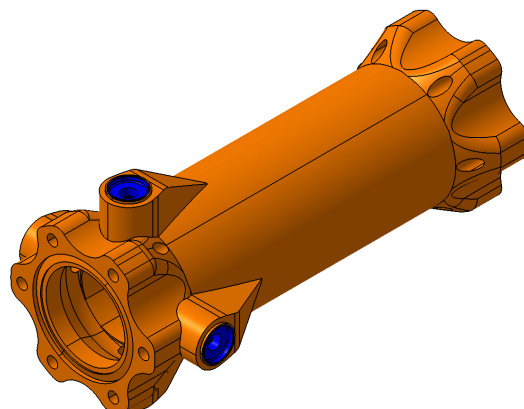

Figure 1: CAD 3D view of the i3D BPM (top) and pictures of the BPM after printing. The shapes have been created by topological optimization. Electrical feedthrough have been added separately.

ties the design was more compact as more complex shapes could be done using additive manufacturing.

STRETCHED WIRE TESTS

To measure the resolution of the BPM we used the stretched wire method. A short beasmline was assembled using two conventional BPMs and this i3D BPM (with beam pipes in between) and a wire was stretched in their middle as shown on image 2.

Electric pulses (5 V, 10 μ s) were sent on the wire. The signal on the four electrodes of the three BPMs were recorded with a Libera Brilliance+ [4] in single pass mode while the BPM triplet was moved vertically using a stepper motor.

Example of data acquired are shown on figure 4. The horizontal axis is the estimated position according to the translation stage settings and the vertical axis is the value calculated by the libera based on the signal read on the electrodes. The figure shows the position for the two conventional BPMs (green and blue dots) and the i3D BPM (red dots). As can be seen the measure for the three BPMs are similar indicating that the i3D BPM has a response similar to that of the conventional BPMs.

* Work supported by the CNRS/IN2P3 under the 3D-Metal program.

[†] delerue@lal.in2p3.fr

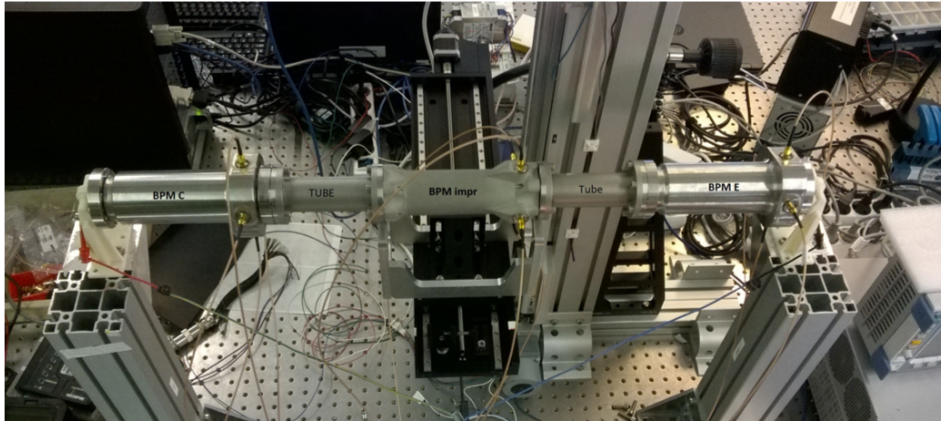

Figure 2: The test bench where the three BPMs have been measured. The BPM built using additive manufacturing is in the middle and the two ones built using conventional means are on the ends. Translation stages allow to move the BPMs vertically and horizontally (transverse to the BPM axis). A conducting metallic wire is stretched through the BPMs and electric pulses are sent on it.

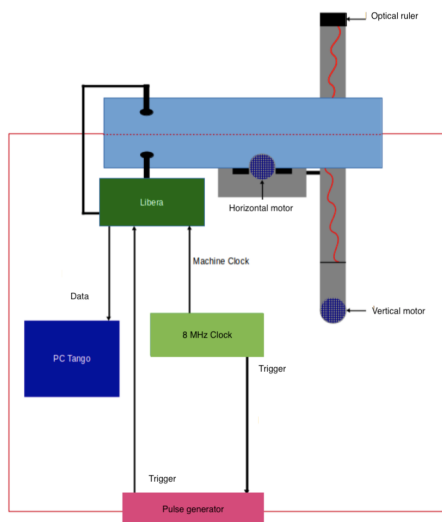

Figure 3: Measurement setup: a pulse generator is used to send pulses on the stretched wire and trigger signals to the machine clock (8 MHz generator) and to the libera. The libera reads the signal on the four electrodes of each of the three BPMs. The data recorded by the libera are read by a PC using Tango.

BEAM TESTS

Following these tests we decided to install the BPM triplet on a real electron accelerator, that is the Photo-injector PHIL [5] (see image 5). The BPMs, including the i3D BPM were cleaned and leak tested by the LAL Vacuum group who approved them for installation in the Ultra High Vacuum of the photo-injector.

The BPMs were installed in the accelerator beam line after a focusing solenoid and two steering magnets. The beam energy was 3.5 MeV and its size at the BPMs location about 2.5 mm. During the experiment changes in the machine settings were then made to see the response of each

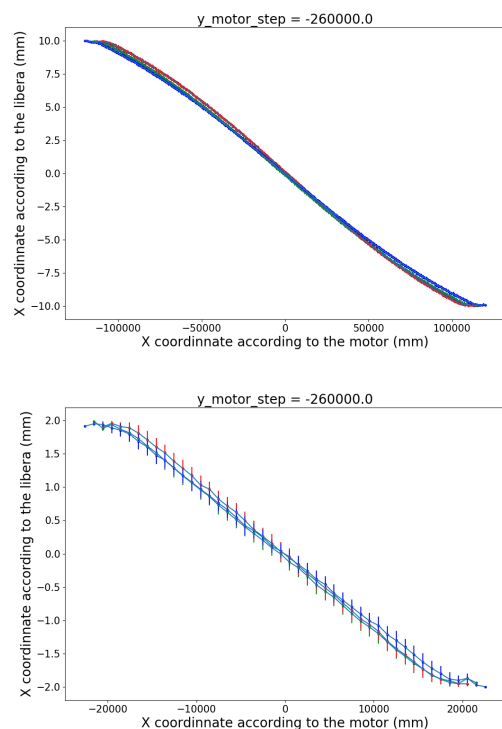

Figure 4: Position measured by the three BPMs (after calculation by the Libera). The horizontal axis shows the estimated position according to the number of steps sent to the motor and the vertical axis shows the measured position. To make the figure easier to read an offset has been applied to the value read by the BPMs so that of the three BPM are reading 0 when the motor is at position 0. The red dots correspond to the i3D BPM and the blue and green dots to the conventionnel BPM.

BPM to these changes. We found that the i3D BPM had overall higher readings on all electrodes, indicating that the

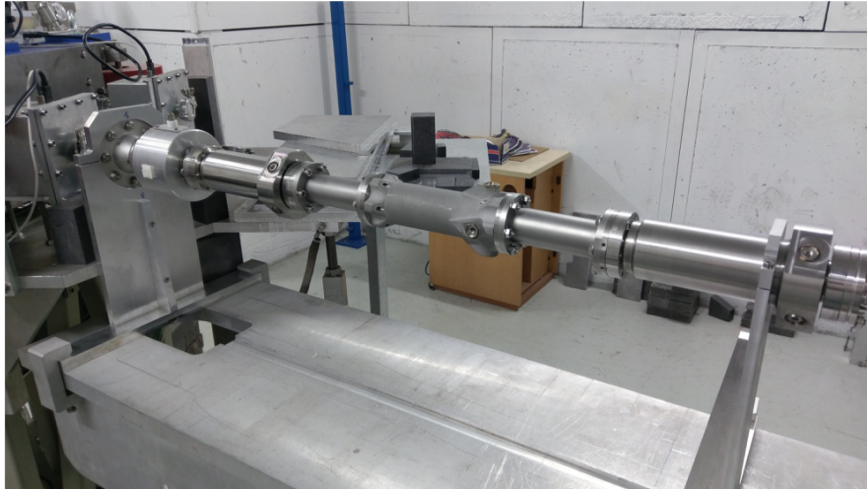

Figure 5: The BPM triplet installed on PHIL. The beam is coming from the left to the right. On the picture one can see (from left to red), first an ICT then one of the conventional BPM, the i3D BPM and the other conventional BPM. There is no magnetic element between the BPMs.

electrode pick-up was better. This can be explained by a better impedance matching of the electrodes of this BPM than that of the other BPMs. An example of raw data measured with this BPM triplet is shown on figure 6.

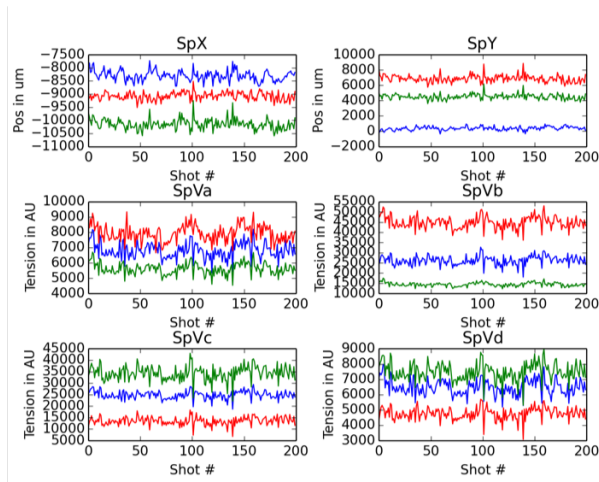

Figure 6: Bottom four plots: Reading by each of the four electrodes (SpVa, SpVb, SpVc and SpVd) of the three BPMs (represented by three colors, red, blue and green, the i3D BPM is in red). Top two plots: X (horizontal) and Y (vertical) position of the beam calculated by the libera. Given that the reading the i3D BPM were higher a factor two higher attenuation was applied to these electrodes. The data were acquired in single pass mode.

As there was no magnetic element between the BPMs, the electron beam follows a ballistic trajectory as it travels through the triplet. It is thus possible to measure the accuracy of the position measurement of the triplet by comparing the reading of the center BPM with the reading expected by drawing a straight line between the two other BPMs. The result of such analysis is shown on figure 7. As we can see the

difference between these two values is less than $200 \mu\text{m}$ in the horizontal plane (x) and less than $400 \mu\text{m}$ in the vertical plane (y). These difference are similar to those observed using conventional BPMs only and thus using an additively manufactured BPM did not degrade the position resolution of the triplet.

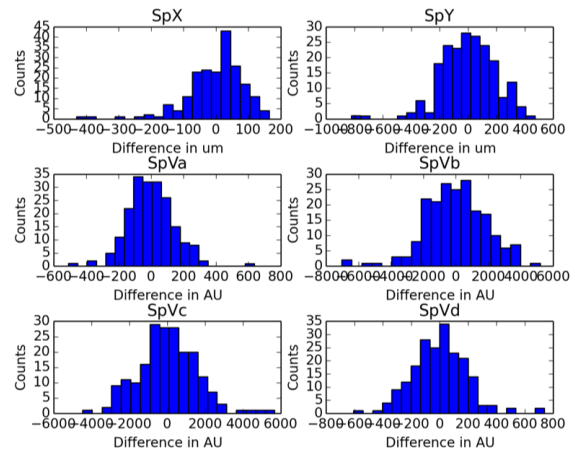

Figure 7: Difference between the position calculated by drawing a straight line between the two outer BPMs and the central one.

OUTLOOK

The tests we have done show that the performances of a BPM built using additive manufacturing are comparable or better than those of a BPM built using conventional methods. Following these tests we decided that future BPMs installed on the ThomX accelerator will be made using additive manufacturing so that we can gain experience over a long period and confirm that the performances remain comparable or better than those of a conventional BPM.

ACKNOWLEDGEMENTS

We are grateful to the IN2P3 "3D Metal" network who funded part of the work reported here.

REFERENCES

- [1] S. Jenzer *et al.*, "Study of the Suitability of 3D Printing for Ultra-High Vacuum Applications", in *Proc. 8th Int. Particle Accelerator Conf. (IPAC'17)*, Copenhagen, Denmark, May 2017, pp. 3356–3358. doi:10.18429/JACoW-IPAC2017-WEPVA043
- [2] G. Sattonnay *et al.*, "Is It Possible to Use Additive Manufacturing for Accelerator UHV Beam Pipes?", presented at the 10th Int. Particle Accelerator Conf. (IPAC'19), Melbourne, Australia, May 2019, paper WEXXPLS3, this conference.
- [3] N. Delerue *et al.*, "Study of the Performances of a 3D Printed BPM", in *Proc. 9th Int. Particle Accelerator Conf. (IPAC'18)*, Vancouver, Canada, Apr.-May 2018, pp. 3656–3659. doi:10.18429/JACoW-IPAC2018-THPAL016
- [4] S. Condamoor *et al.*, "Machine Studies with Libera Instruments at the SLAC Spear3 Accelerators", in *Proc. 7th International Beam Instrumentation Conference (IBIC'18)*, Shanghai, China, Sep. 2018, paper TUPB12, pp. 284.
- [5] M. Alves *et al.*, *JINST* **8** (2013) T01001 doi:10.1088/1748-0221/8/01/T01001 [arXiv:1209.6222 [physics.acc-ph]].