

The MINOS Experiment & Long Baseline ν Oscillation Programs in Europe and U.S.

Jon Urheim, U. of Minnesota

ICHEP 2002, Amsterdam, 27 July 2002

- Introduction
- MINOS Experiment Overview
- Status of MINOS – Construction & First Data
- Status of CNGS – [thanks to S. Katsanevas]
- Near-Future Initiatives in Europe and US

The MINOS Experiment & Long Baseline ν Oscillation Programs in Europe and U.S.

Jon Urheim, U. of Minnesota

ICHEP 2002, Amsterdam, 27 July 2002

- Introduction
- MINOS Experiment Overview
- Status of MINOS – Construction & First Data
- Status of CNGS – [thanks to S. Katsanevas]
- Near-Future Initiatives in Europe and US

Introduction



- **picture emerging from existing data**
 - **Large effect at “atmospheric” Δm^2**
 - oscillation hypothesis very strong [Super K]
 - effect now seen at accelerator expt. [K2K]
 - dominant mode likely to be $\nu_\mu \rightarrow \nu_\tau$ [Super K]
 - **Also large effect at “solar” Δm^2** [Davis]
 - could be the LMA solution !! [Ga + SNO + SK]
 - **Questions:**
 - two angles large, what about the third θ_{13} ?
 - complex phase in MNS matrix \rightarrow CPV ?
 - what about CPT ? sterile neutrinos ? Extra dimensions ? where does LSND fit ?

Goals of 1st generation of Long Baseline Experiments



Confront emerging picture with precision data

- confirm deficit of ν_μ in accelerator-based exp't
- confirm oscillation hypothesis:
 must measure/know E & L precisely to see osc'ns in L/E
 pin down oscillation parameters
- demonstrate $\nu_\mu \rightarrow \nu_\tau$ is dominant mode:
 Tau appearance ! (CNGS \rightarrow direct, MINOS \rightarrow NC/CC)

Look for new phenomena

- evidence for non-zero θ_{13} : \rightarrow detection of ν_e
- test for possible CPT violation ?
- etc....

The MINOS Collaboration

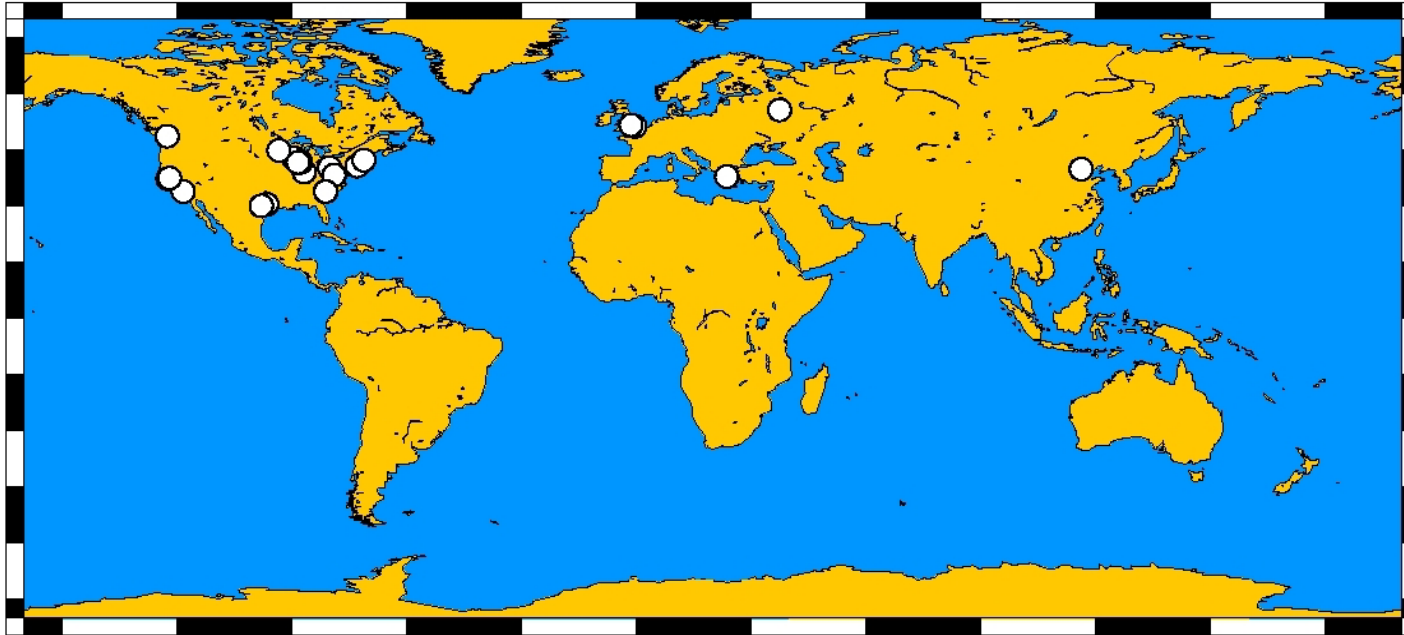

IHEP-Beijing • College de France • Athens • Dubna • ITEP-Moscow • Lebedev • Protvino
• Cambridge • Oxford • Rutherford • Sussex • University College London • Argonne •
Brookhaven • Caltech • Illinois Inst of Tech • Fermilab • James Madison • Harvard •
Indiana • Livermore • Minnesota-Twin Cities • Minnesota-Duluth • Northwestern •
Pittsburgh • South Carolina • Stanford • Texas-Austin • Texas A&M • Tufts •
Western Washington • Wisconsin

~30 Institutions ~250 physicists & engineers

NuMI / MINOS Concept

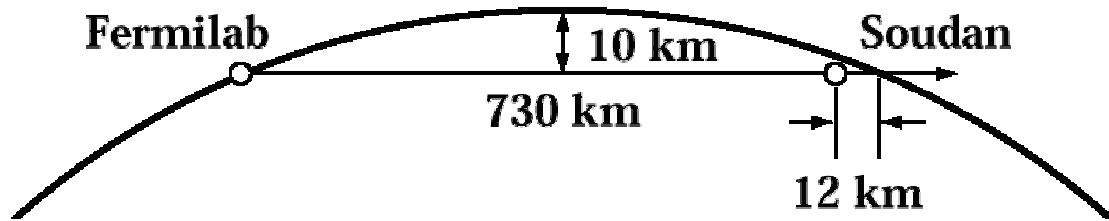

ν_{μ} source: (NuMI)

120 GeV protons from FNAL Main Injector

detectors: (MINOS)

1) 'Far' detector:

5.4 kT magnetized iron/scintillator
 tracker/calorimeter in Soudan mine

2) 'Near' detector:

980 T version of far detector at FNAL

3) Also:

'Calibration' detector
 in test beams at CERN

NuMI & The Main Injector

Fermilab Main Injector:

120 GeV protons
 4×10^{13} protons/pulse
1.9 sec rep rate
(~8 μ sec spill)
→ 0.4 MW

NuMI Beam:

Graphite target
Two magnetic horns
675 m. vac. decay pipe
hadron absorber

Beam Monitoring:

muon detectors
hadron detectors
+ Near Detector !

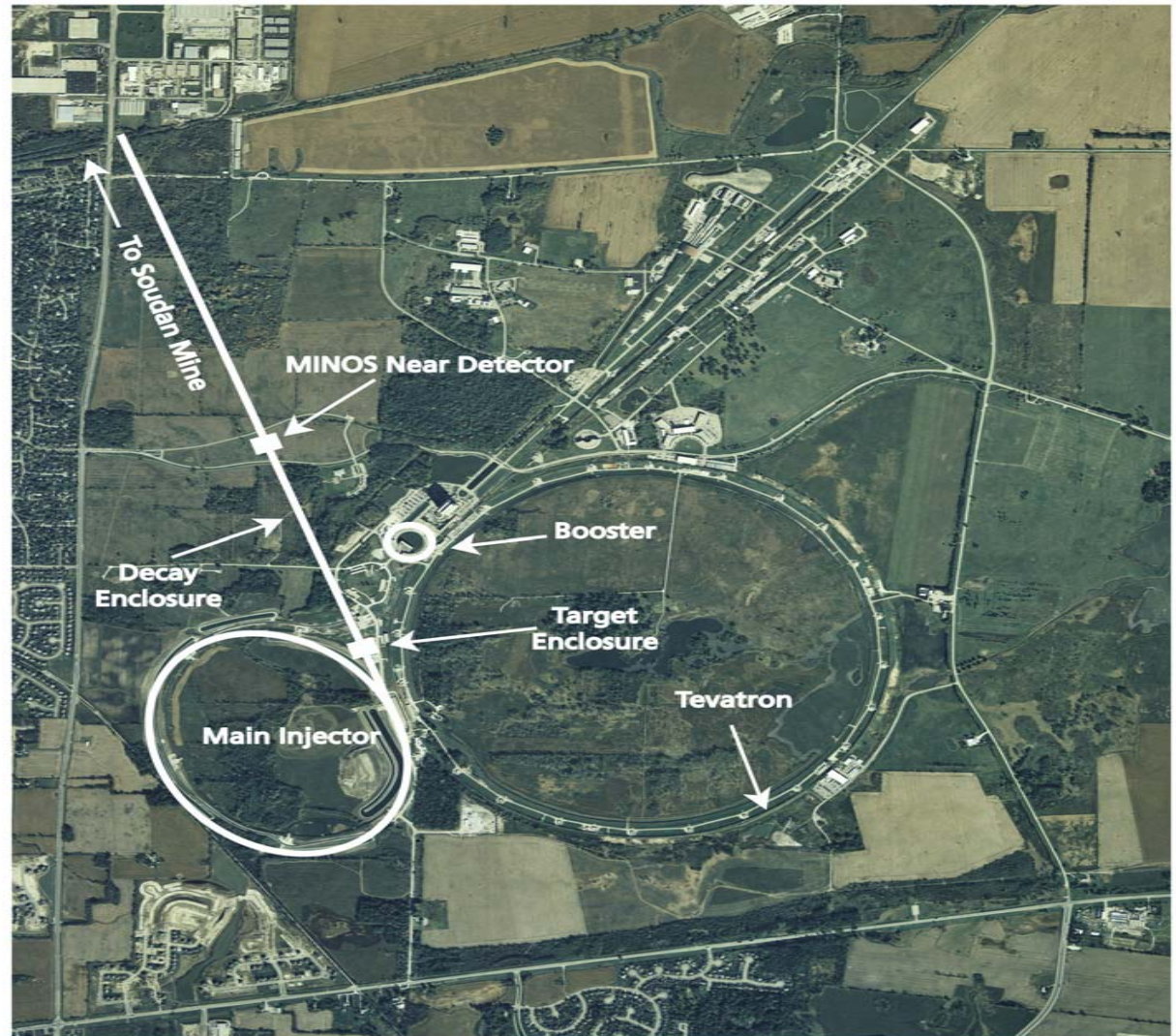

Soudan Underground Laboratory

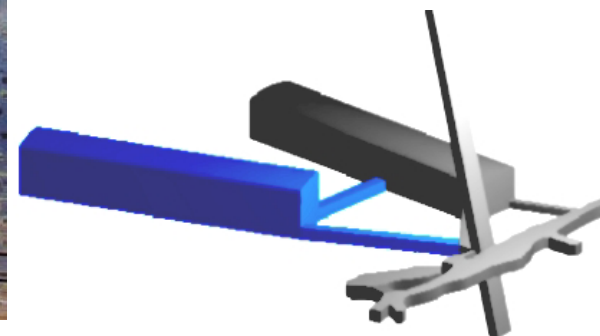

- **former iron mine, now a state park,**
 - **home of: Soudan-1 & 2 , CDMS-II , and MINOS expts**



The MINOS Far Detector

Steel / Scintillator :

2.5 cm thick steel
 4 cm x 1 cm polystyrene
 – encased in Al cover
 15,000 Amp-turn coil

486 Layers → 5.4 kTon !

Readout:

WLS fibers glued into
 groove in scintillator
 – double-ended readout

Hamamatsu M16 pmt's
 – 8-fold optical summing

IDE 'VA' front-end chips
 pulseheight & time

GPS to synch to MI spill

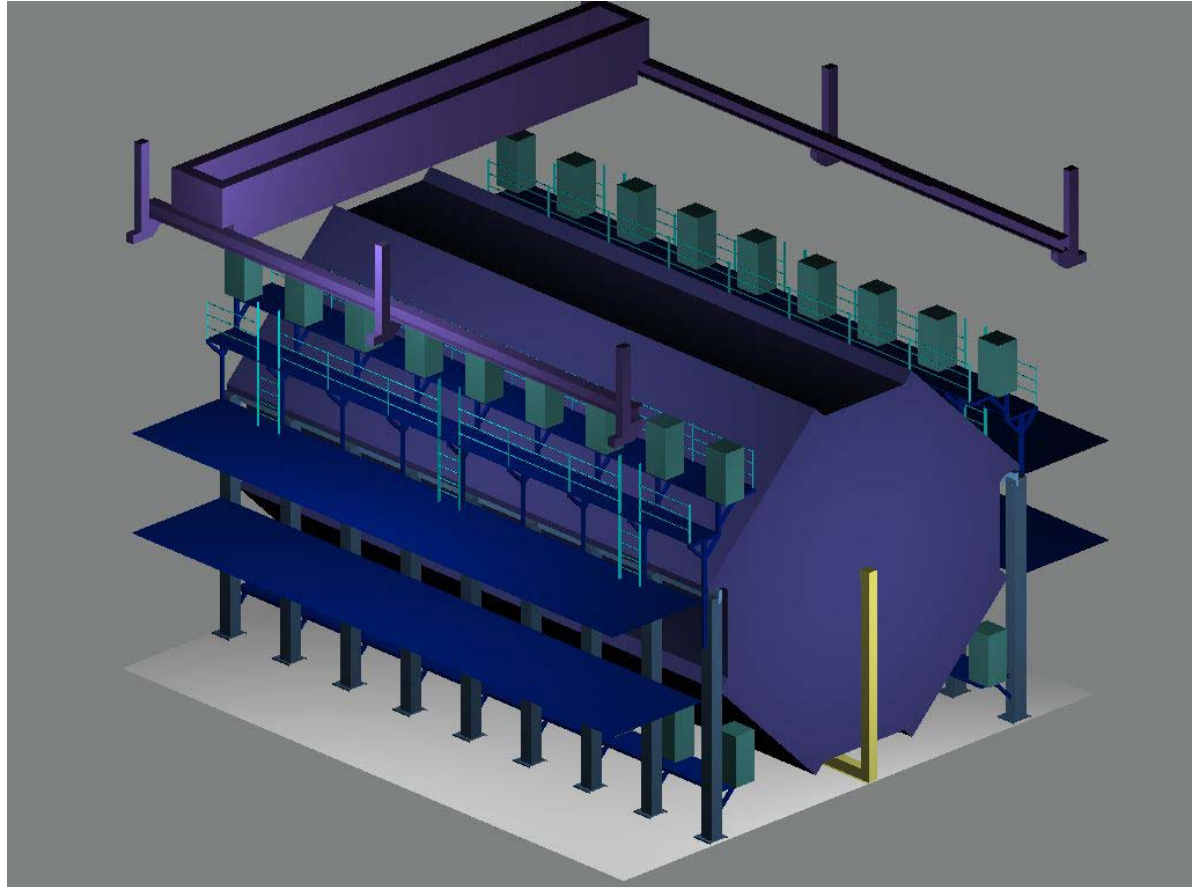

Shown here: 1 (of 2) super modules
 – **248 planes: 8m x 8m x 15m !**

Far Detector Module Layout

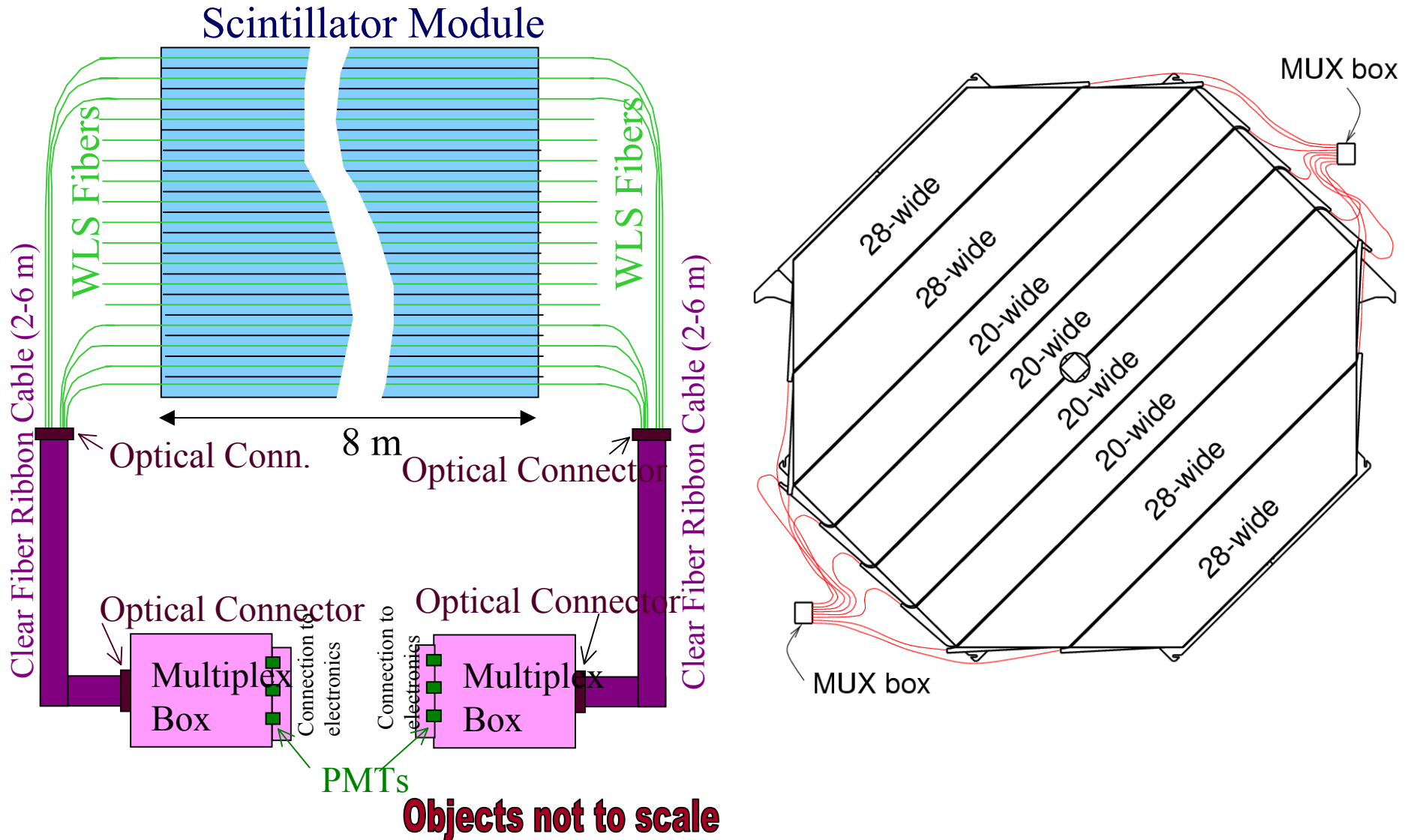

Scintillator Detectors & PMTs



Spool of 1.2 mm WLS fiber being glued into groove

Hamamatsu M16 16-channel PMT (8 fibers per pixel)



4.1 cm x 1 cm polystyrene strips – coextruded with TiO₂ coating & groove for WLS fiber

The MINOS Near Detector

1 Ton version of far det.

290 m d/s of hadron absorber
 → beam is small !

→ 4 regions:
 'veto' + 'target' + 'shower'
 + 'spectrometer' (sparse)

make as similar to
 far detector as possible !

Readout:

Hamamatsu M64 pmt's

High instantaneous rates
 (~50 ν events / 8 μ sec spill)
 → fast front ends needed

→ use FNAL QIE chips
 (based on KTeV version)

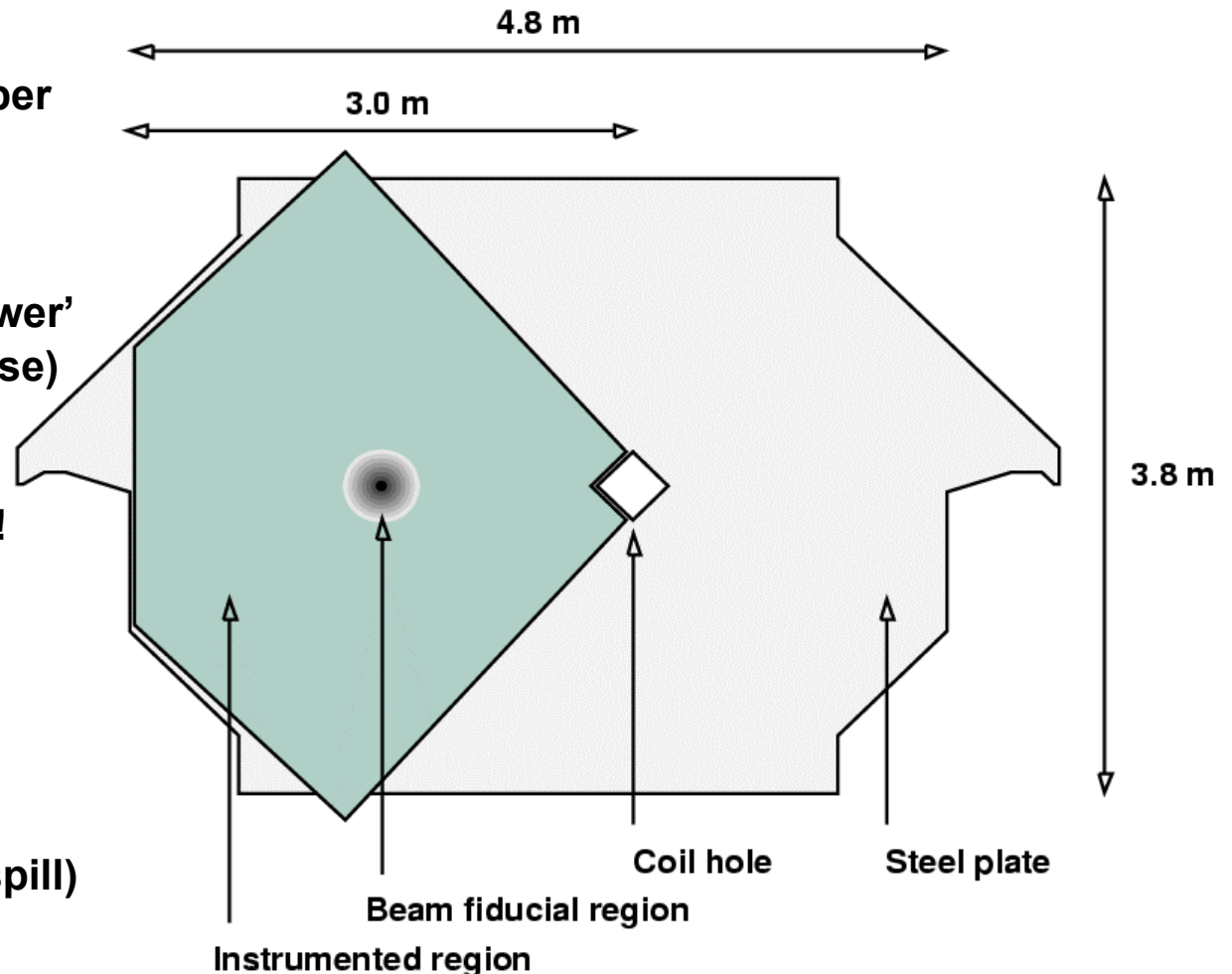

Simulated Neutrino Interaction

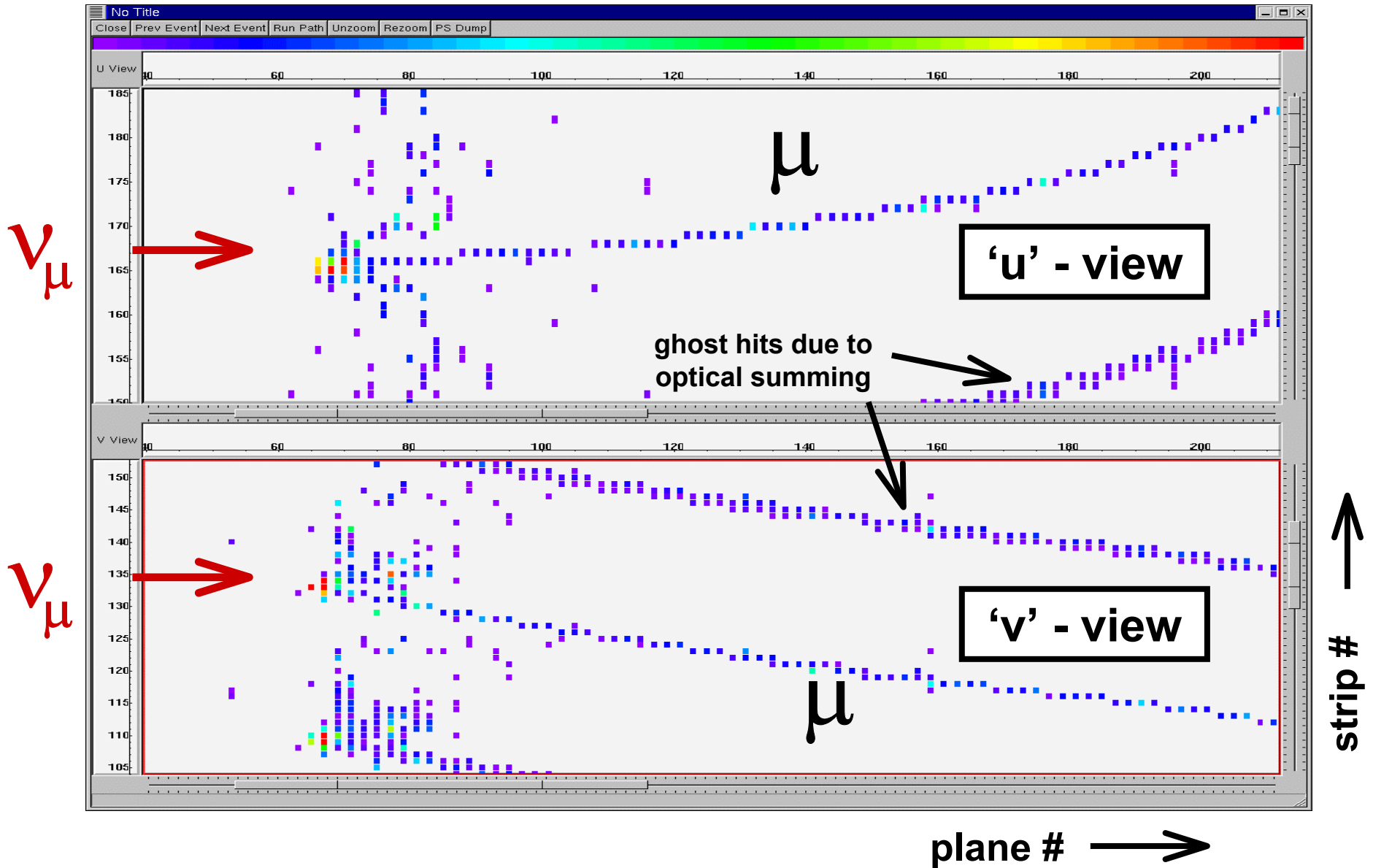

Beam Energy Considerations

Pre – Super K:

$$\Delta m^2 \sim 0.01 \text{ eV}^2 \text{ (IMB, Kam..)}$$

- NuMI ‘high energy beam’ gives best sensitivity
- good prospects for observation of ν_τ

Post – Super K:

$$\Delta m^2 \sim 0.001 - 0.004 \text{ eV}^2$$

- Can’t increase “L”
- High energy beam no longer desirable !
- But NuMI beam was designed to be tunable !

From: Battistoni & Lipari,
hep-ph / 9807475

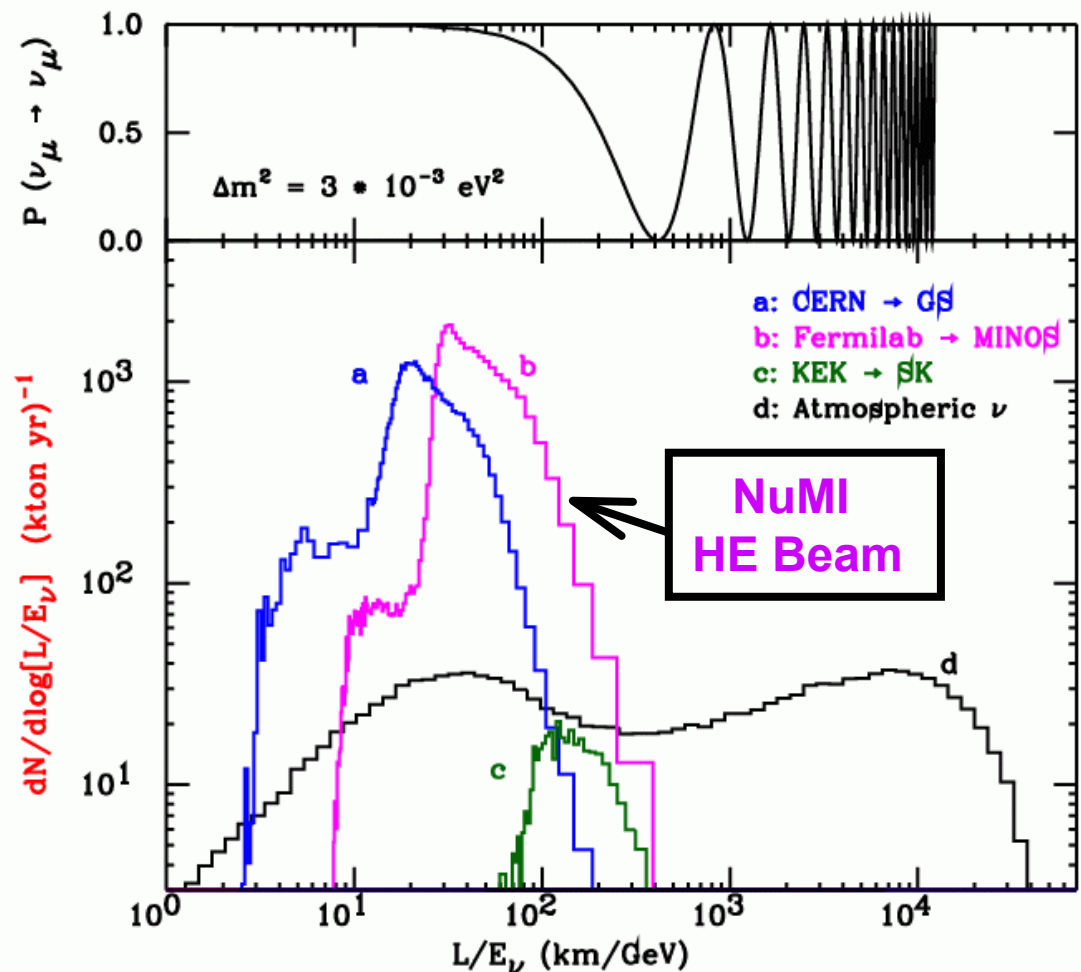

Configurable 2-Horn Design

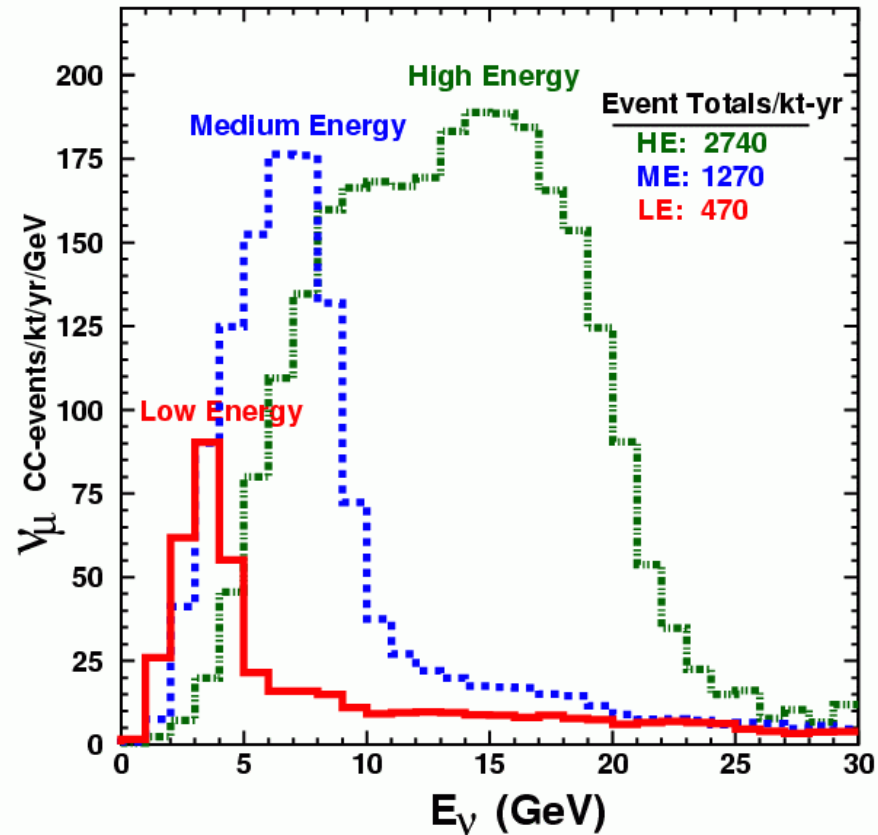
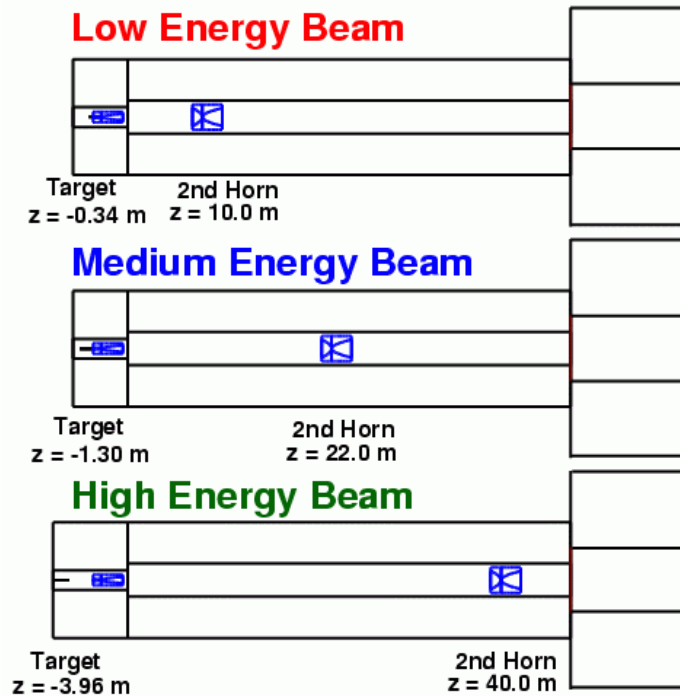

- Low energy beam: less flux, but better match to Δm^2
- Still plenty of events: **~ 5000 ν_μ CC events in 2 yrs**



Expected Neutrino Energy Dist'ns

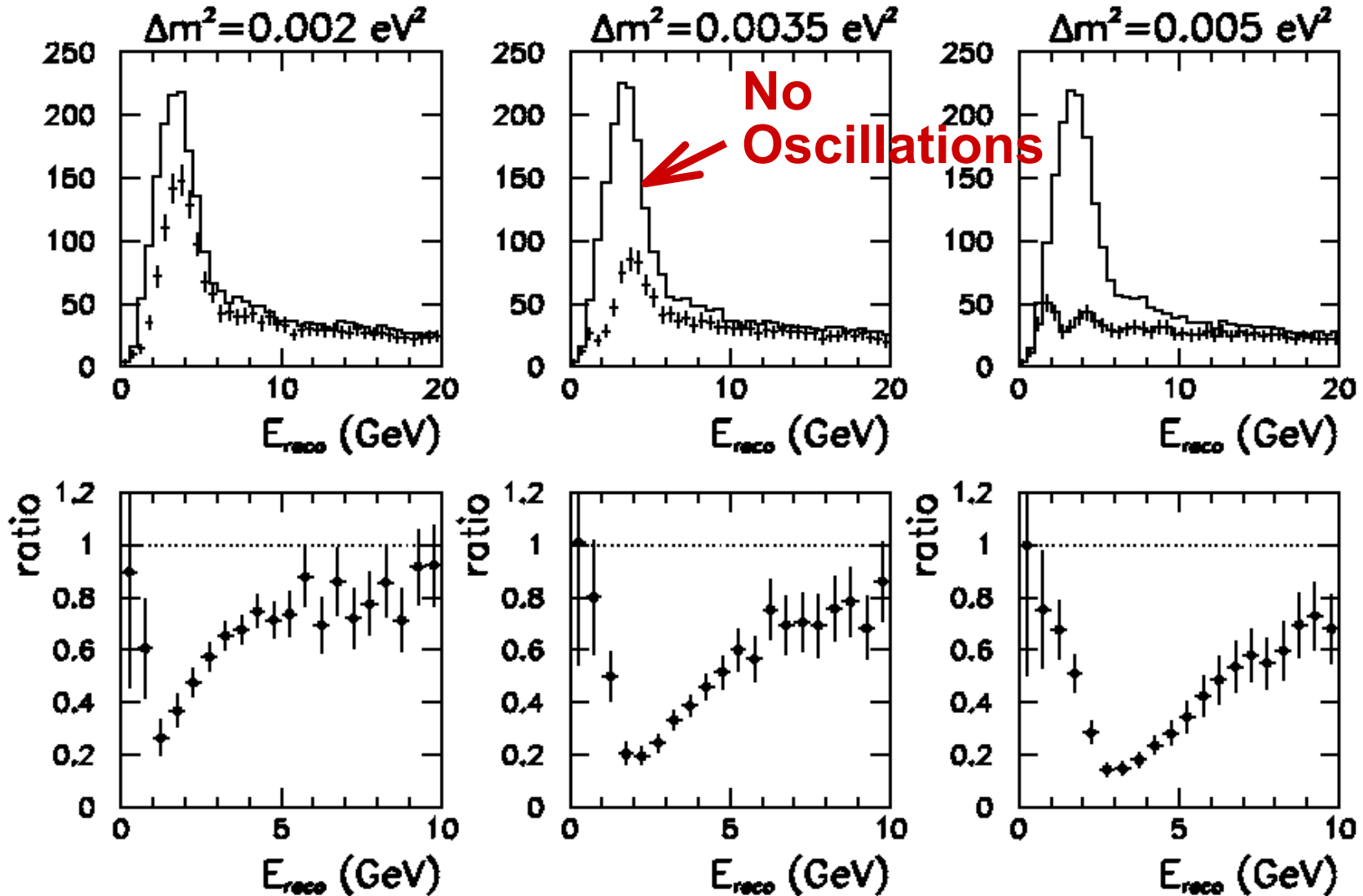

- What we might see in 2 yrs of running



MINOS sensitivity to Oscillations

Two-neutrino mixing:

see figure at right → 2 yrs

note: we expect to run longer !

Search for ν_e appearance:

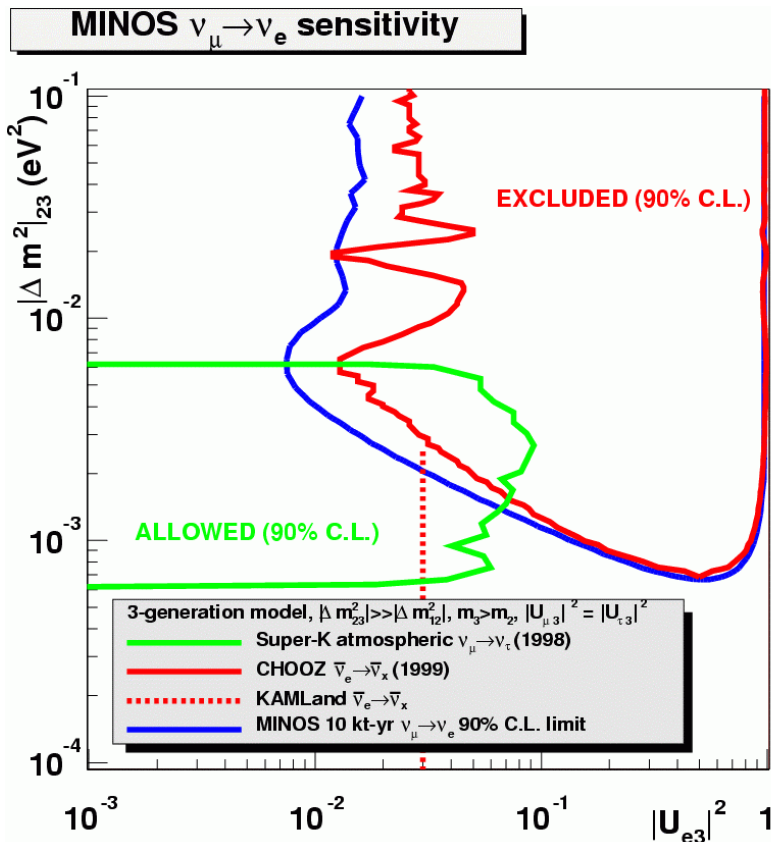

Ph2Ie, 10 kt. yr., 90% C.L.

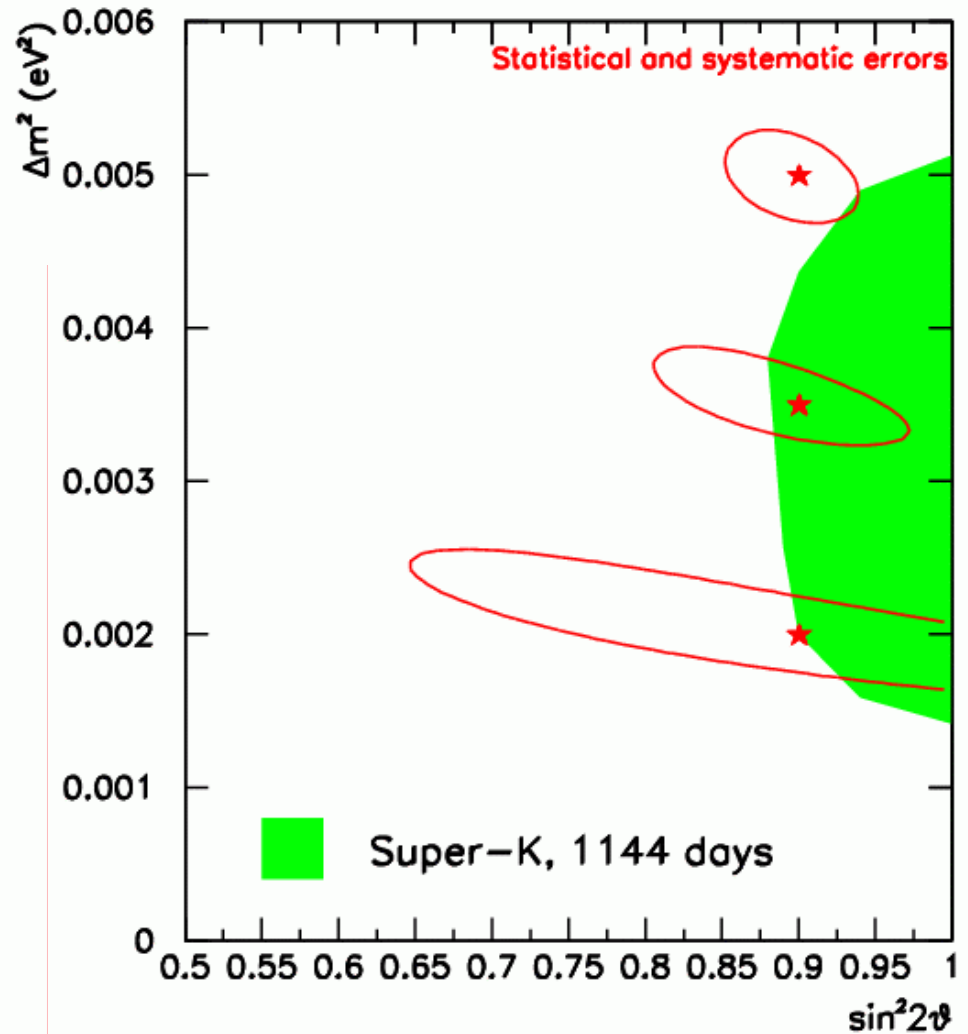

Status of Far Detector Construction



27 July 2002



Status of Detector & Beam Construction (cont'd)

- **Far Detector Supermodule 1 completed, 24 June**
 - 248 planes, (~7 planes per week since Aug, '01)
 - Coil now installed, to be energized this week !
 - Supermodule 2 already being assembled → finish in April '03
- **Near Det. Plane Assembly ongoing at FNAL**
 - Being done on surface while expt'l hall is outfitted
 - Excellent progress so far
- **Excavation of Beam Line & Near Det. Hall is done**
 - Installation of 2-m diameter, 675-m long decay pipe under way
 - Prototype horn 1 tested, production horns being fabricated
 - Design of target pile nearly complete
- **NuMI Beam commissioning in late 2004 !!**

NuMI Construction

Horn 2 inner conductor →

NuMI 675-meter decay pipe segment being installed...



Horn 1 prototype, being tested...

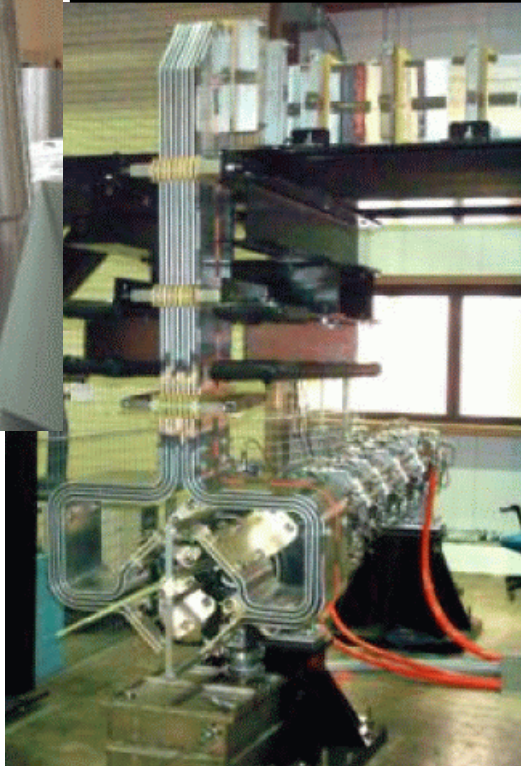



First Look at Far Detector Data

Detector commissioned as construction proceeds:

cosmic ray / atm neutrino data taken mainly nights & weekends

→ exposure measured in kton-months so far !

→ but will run SM 1 ~full-time during construction of SM 2

First attempts to calibrate !

note: 192 strips/plane X
248 planes X 2 ends/strip =
~ 95,000 strip-ends in SM 1

pulse height (min-l) & timing

Calibration Detector at CERN:
relates hadron/em shower energy to min-l depos'n.

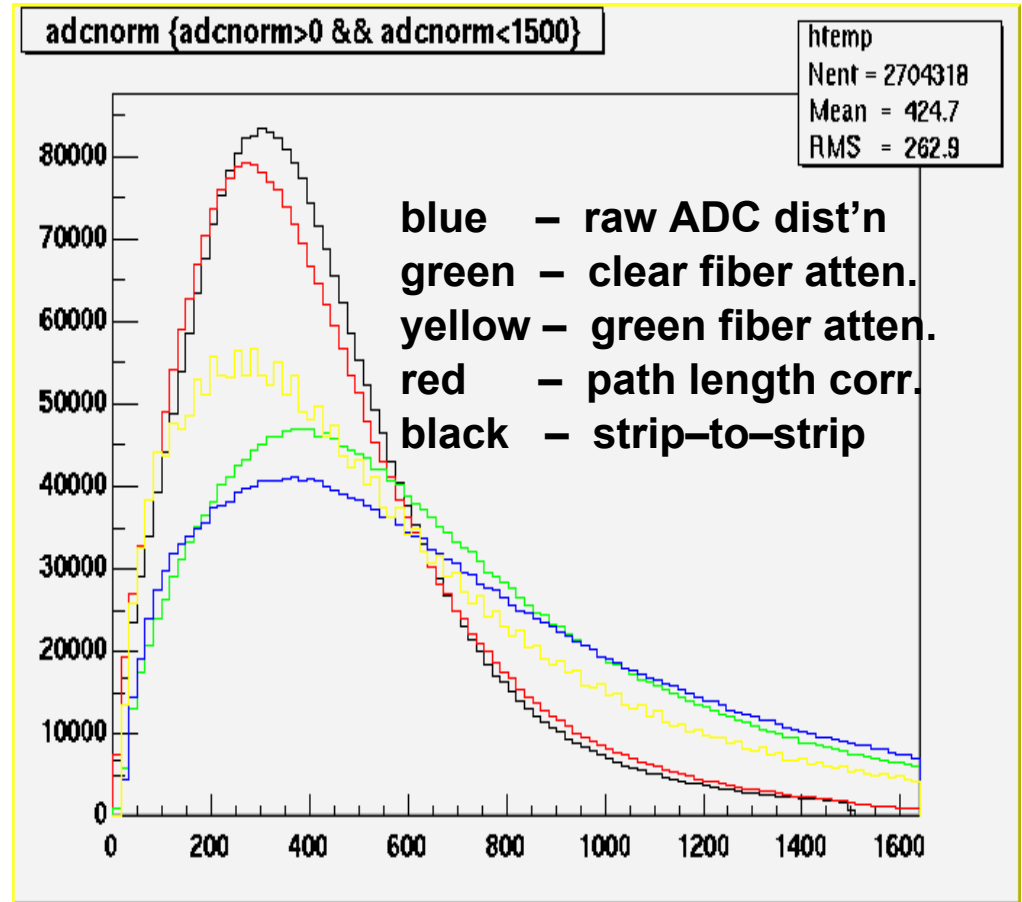

ADC value

Pulseheight Calibration

First upward-going muon !

Muon entered at front face (plane 0),
exited at side (plane 24)
Good timing is key !
Single strip timing resol'n:

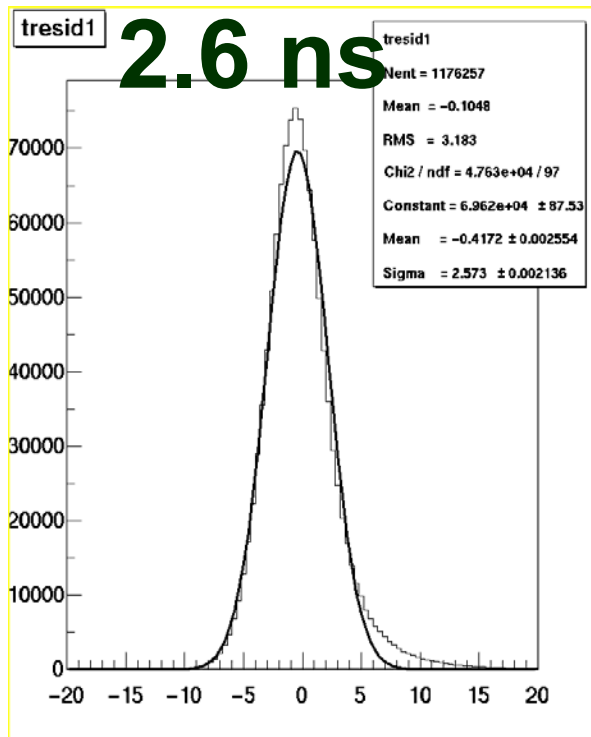

Run 3281, Snarl 2621.
 $\beta^{-1} = -0.850628, \phi = 154.875501, \chi^2 = 0.342965, \text{Planes Hit} = 24$

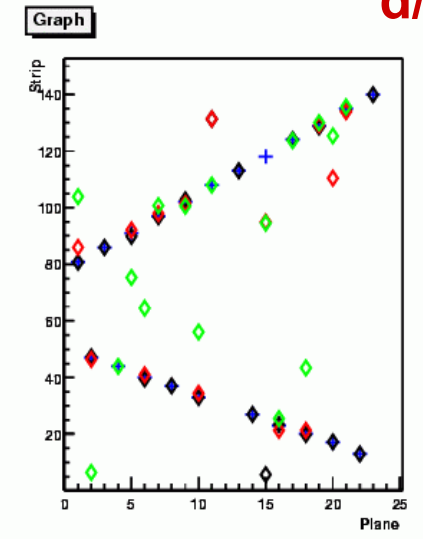
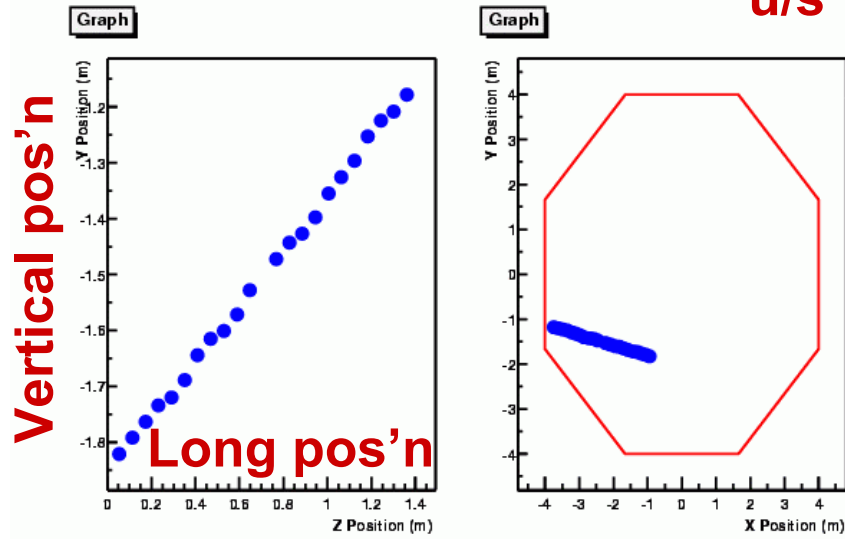
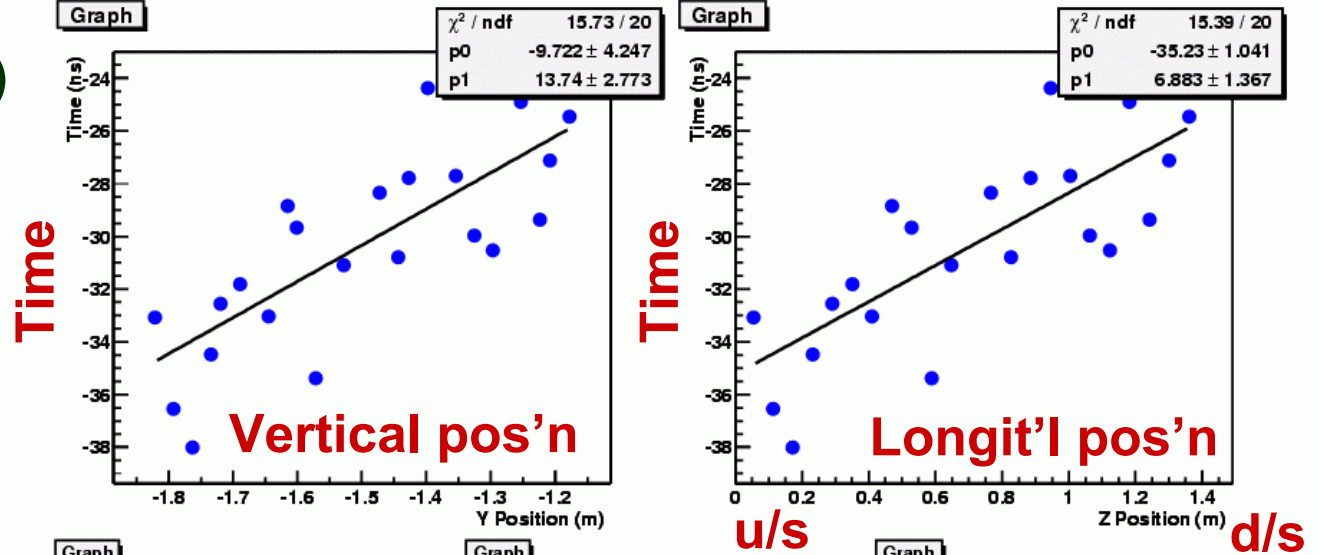

(Downward-going) Candidate: Partially Contained ν_μ Event ?

Neutrino interaction
around plane 60
(large energy deposit)

muon exited through
front face of detector
(plane 0)

Note energy deposited
by muon consistent w/
minimum ionizing

Cosmic ray muon
backgrounds are
non-trivial !

→ veto shield needed?

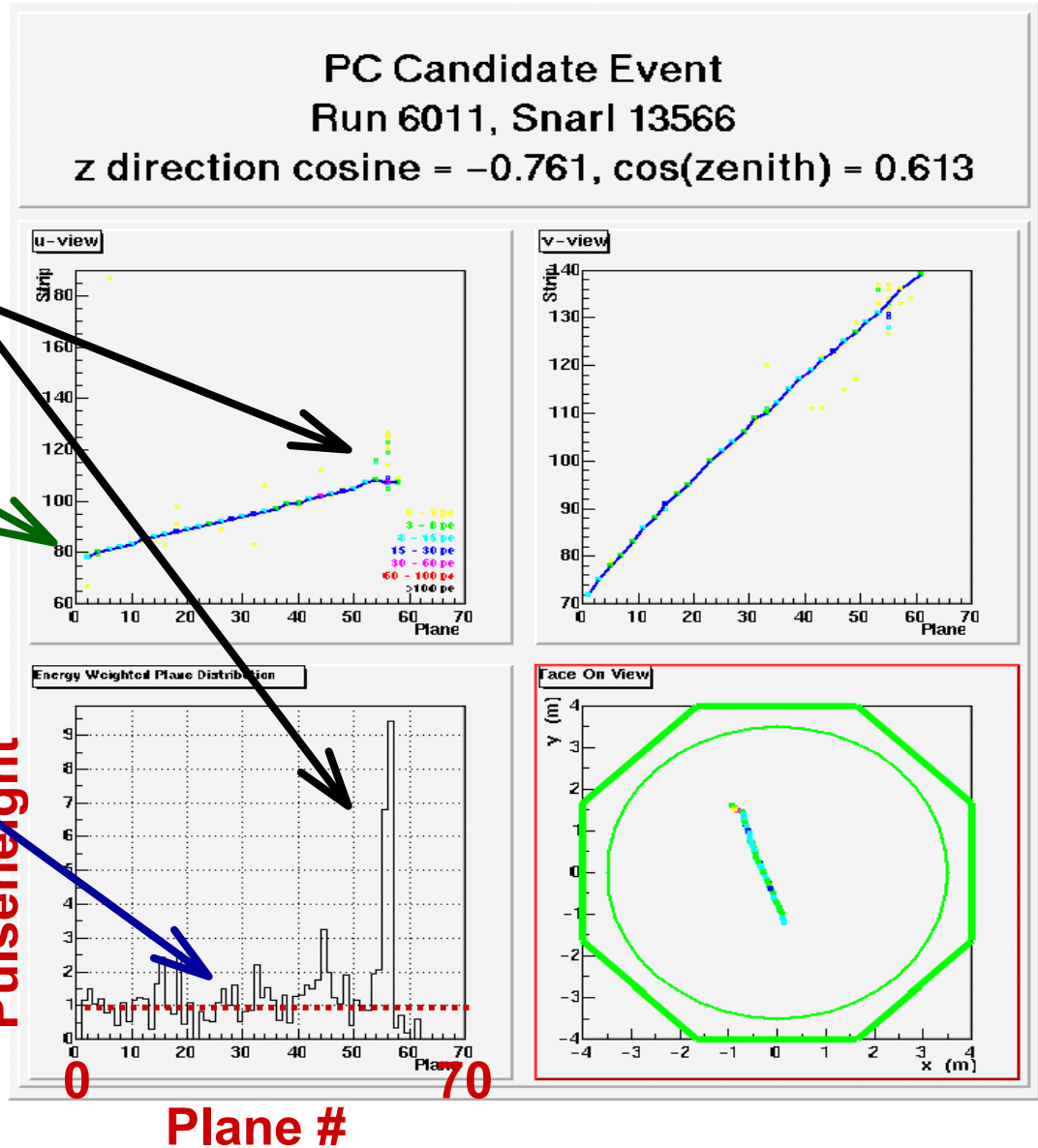

Summary of MINOS

- **Data-taking w/ NuMI beam will begin in late 2004**
 - **Far & Near detector on schedule, Far det. already 1/2 complete** (detector very stable: < 1 ns timing drifts, ~ 1% pulseheight drifts)
 - **Calibration detector running & data analysis will be complete**
 - **much progress on NuMI: civil & technical components**
- **By 2007, will have precise measurements:**
 - **osc'n parameters: $\nu_\mu \rightarrow \nu_\tau$ case;** (NC/CC ratio for mode id)
 - **search for subdominant $\nu_\mu \rightarrow \nu_e$**
- **Will also have ~ 24 kiloton-year exposure to atm. ν 's**
 - **energy, direction resol'n \rightarrow Minos competitive on $\nu_\mu \rightarrow \nu_\tau$**
 - **1st direct search for CPT non-cons. ($\bar{\nu}_\mu \rightarrow \bar{\nu}_\mu$ vs $\nu_\mu \rightarrow \nu_\mu$)**
- **'conventional' neutrino physics w/ near detector**



The CNGS project

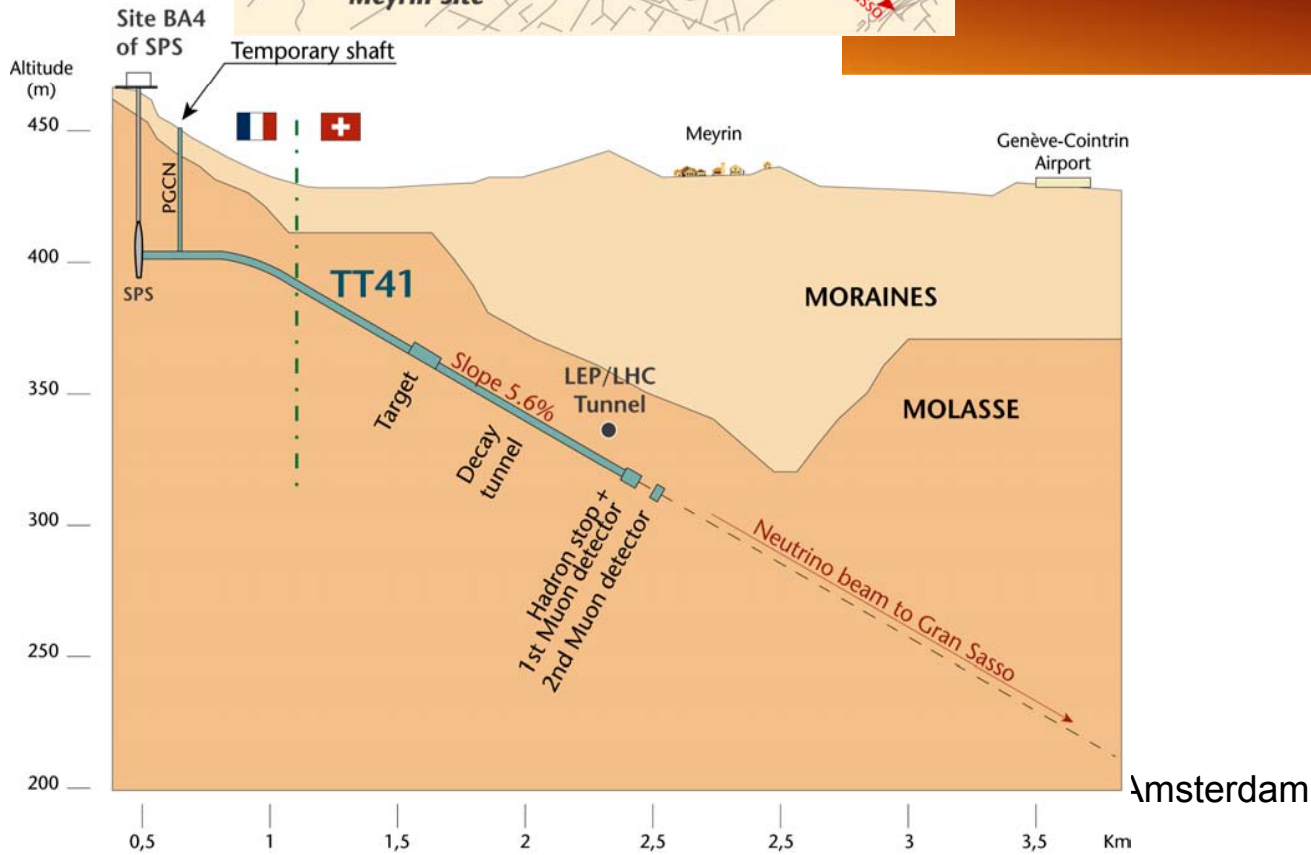
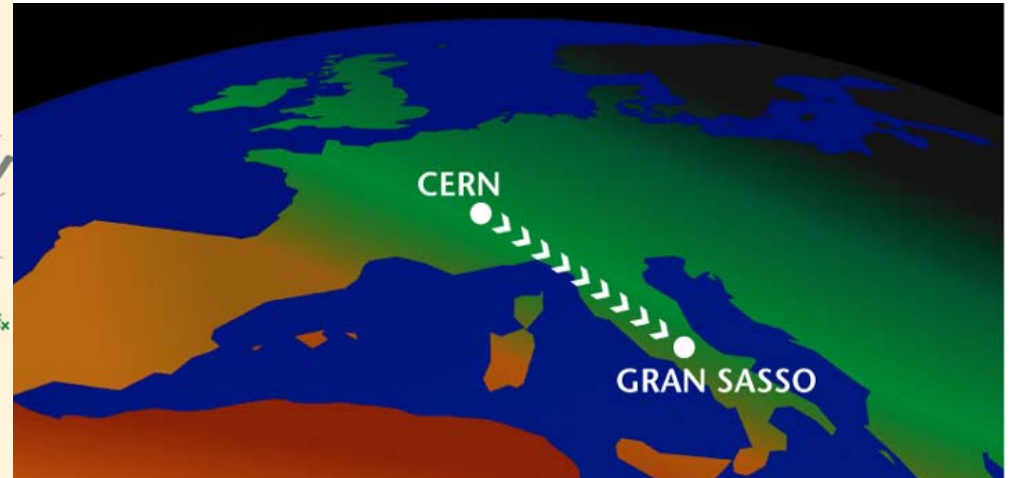
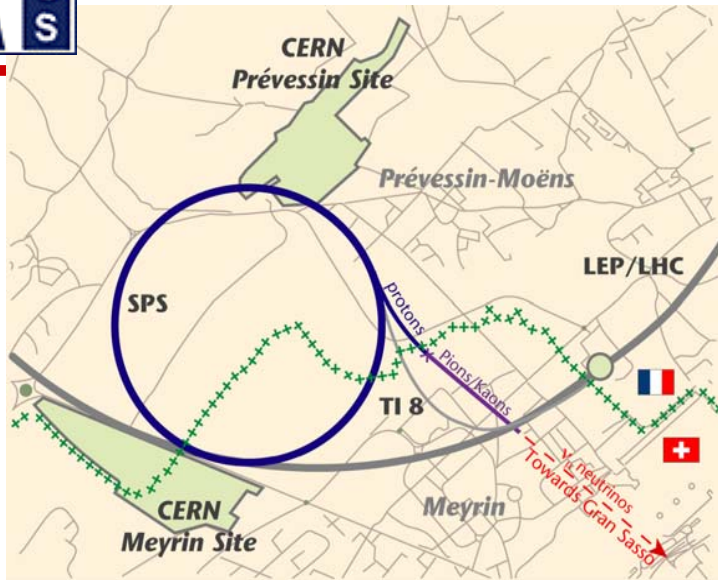

INFN - LNGS
Laboratori Nazionali del Gran Sasso

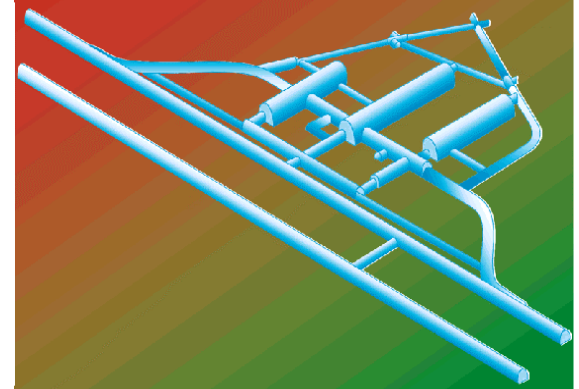

Annual Report 1999



The CNGS Project

- Targeting direct observation of $\nu_{\mu} \rightarrow \nu_{\tau}$
- High energy beam from 400 GeV CERN SPS
 - needed to produce tau's
- Fine-grained detectors: OPERA & ICARUS
 - needed to identify tau decays !
- Excellent capabilities for electron detection
 - can do well on $\nu_{\mu} \rightarrow \nu_e$ search
 - high energy beam a handicap here, unless Δm^2 is large
- **CNGS civil construction far along !!**
 - current projection to deliver neutrinos in 2006 (?)
 - [exact date may depend on CERN schedule for SPS running]



The CNGS Neutrino Beam

Shared SPS operation

200 days/year

4.5×10^{19} pot / year

$\langle E \rangle_\nu$ (GeV)	17
$(\nu_{e^+} + \bar{\nu}_e) / \nu_\mu$	0.87 %
$\bar{\nu}_\mu / \nu_\mu$	2.1 %
ν_τ prompt	negligible

**Slide courtesy
S. Katsanevas**

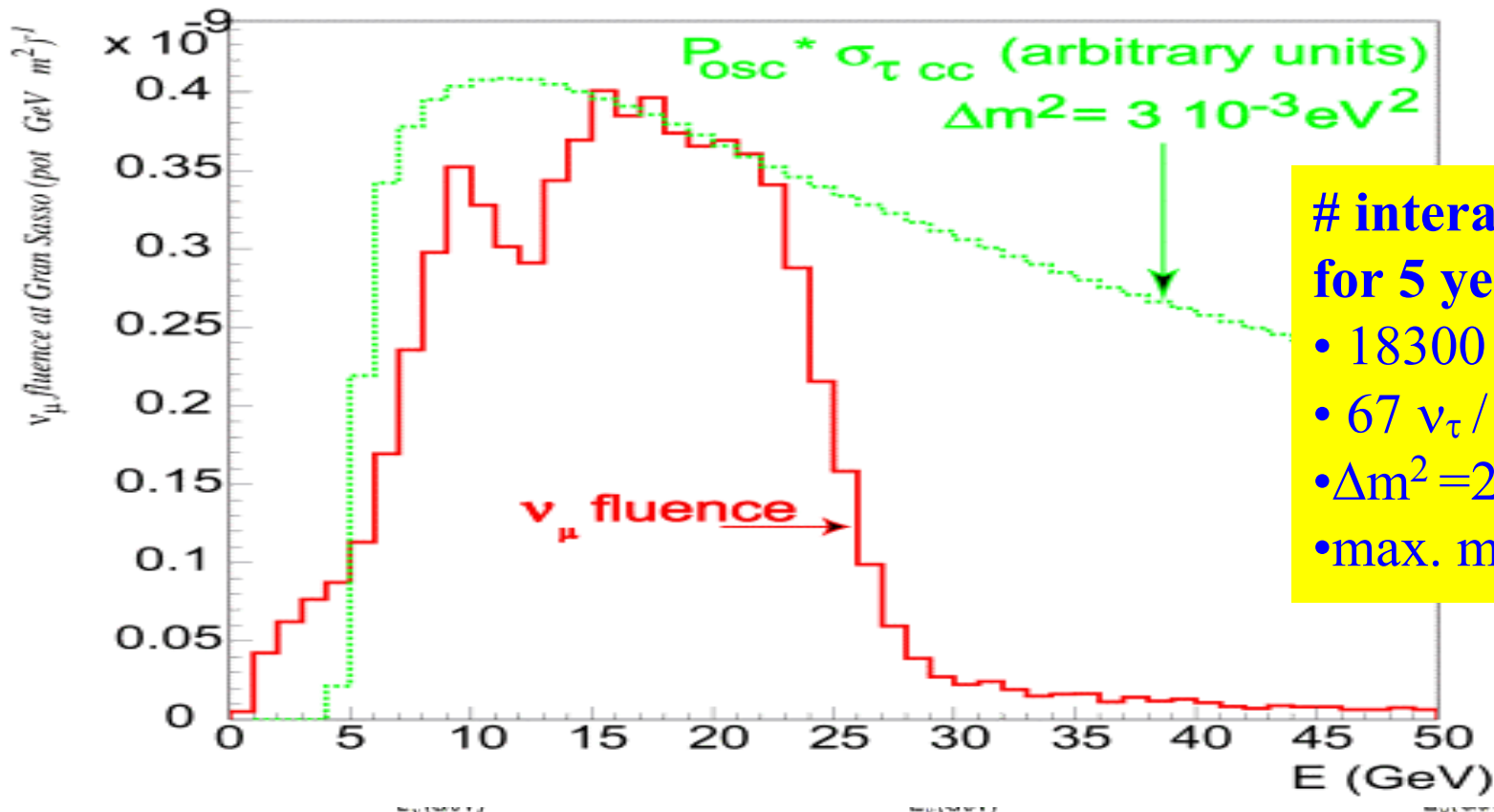

**# interactions ν
for 5 years :**

- 18300 NC+CC / kt
- 67 ν_τ / kt
- $\Delta m^2 = 2.4 \times 10^{-3} \text{ eV}^2$
- max. mixing



COLLABORATION

The OPERA Experiment

Belgium

IIHE(ULB-VUB) Brussels

China

IHEP Beijing, Shandong

Croatia

Zagreb

France

LAPP Annecy, IPNL Lyon, LAL Orsay, IRES Strasbourg

Germany

Berlin, Hagen, Hamburg, Münster, Rostock

Israel

Technion Haifa

Italy

Bari, Bologna, LNF Frascati, L'Aquila, Naples, Padova, Rome, Salerno

Japan

Aichi, Toho, Kobe, Nagoya, Utsunomiya

Switzerland

Bern, Neuchâtel

Russia

INR Moscow, ITEP Moscow, JINR Dubna, Obninsk

Turkey

METU Ankara

34 groups
~ 170 physicists

OPERA = CNGS1
Approved



OPERA Detector: Emulsion

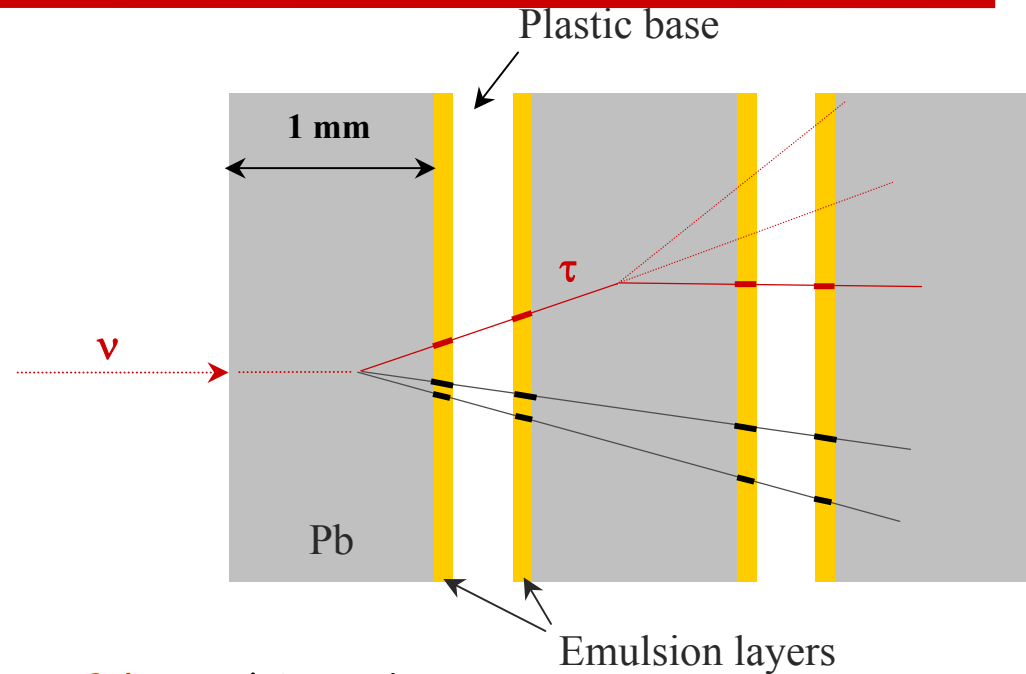
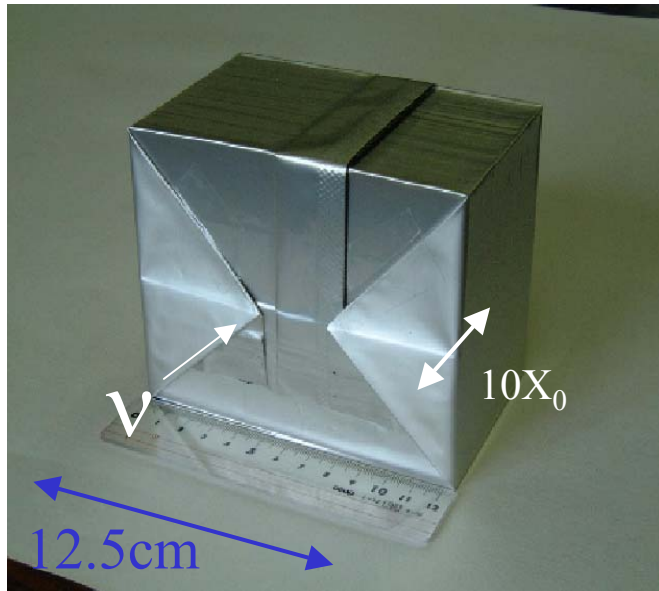

56 **emulsion films** / brick

- To the full detector:
 - 2 supermodules
 - 31 walls / supermodule
 - 52 x 64 bricks / wall
 - 200 000 bricks

~2 kTon (Pb)
0.04 kTon emulsion

Slide courtesy
S. Katsanevas



Electronic detectors to select bricks with ν interactions (plastic scintillator strips)

- Target Tracker tasks :
 - select bricks efficiently
 - initiate muon tagging

Sampling by Target Tracker planes (X,Y)

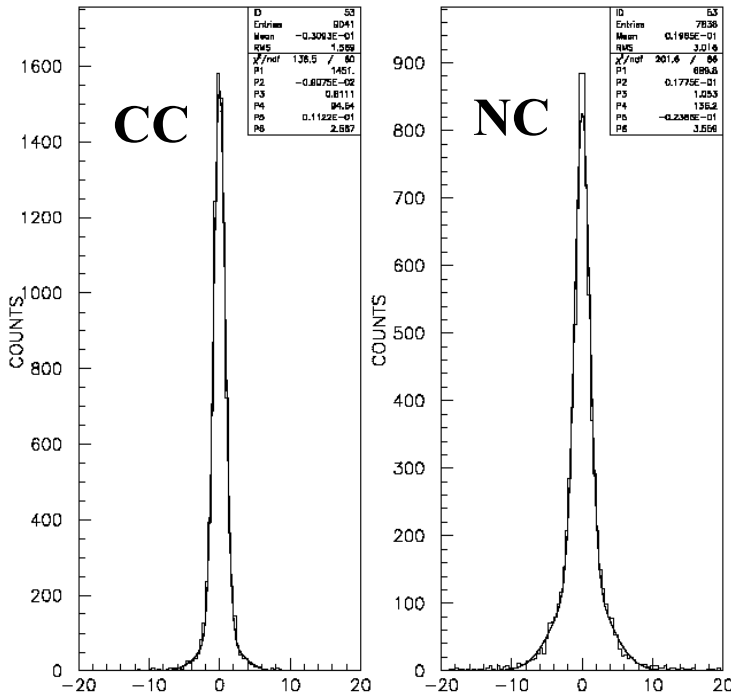

$X_{\text{true}} - X_{\text{rec}} \text{ (cm)}$

$\sigma = 1.5 \text{ cm CC}$
 3.0 cm NC

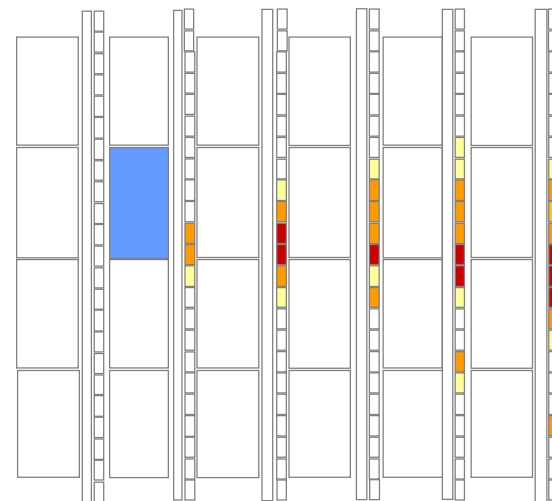
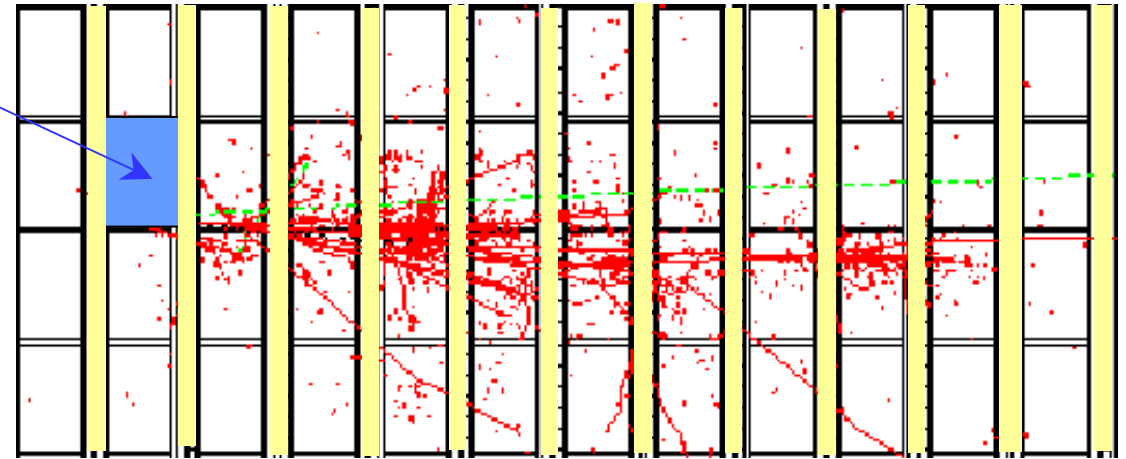

Slide courtesy
S. Katsanevas
Event as seen by the
Target Tracker

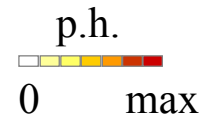

OPERA Experiment Sensitivity

- Sensitivity to many decay modes of tau lepton
- Expect to take data for 5 yrs → 9 kTon-yrs.
- Low Backgrounds (0.75 events)

- Expected event yields:
 - $\Delta m^2 = 1.2 \times 10^{-3} \text{ eV}^2$: 2.7 events
 - $\Delta m^2 = 2.4 \times 10^{-3} \text{ eV}^2$: 11 events
 - $\Delta m^2 = 5.4 \times 10^{-3} \text{ eV}^2$: 54 events

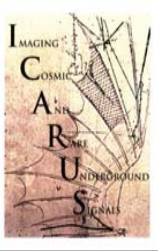

The ICARUS Collaboration

F. Arneodo, B. Babussinov, B. Badelek, A. Badertscher, M. Baldo-Ceolin, G. Battistoni, B. Bekman, P. Benetti, E. Bernardini, A. Borio di Tigliole, M. Bischofberger, R. Brunetti, A. Bueno, E. Calligarich, D. Cavalli, F. Cavanna, P. Cennini, S. Centro, A. Cesana, C. Chen, Y. Chen, D. Cline, P. Crivelli, A. Dabrowska, M. Daszkiewicz, C. De Vecchi R. Dolfini, M. Felcini, A. Ferrari F. Ferri, A. Gigli Berzolari, I. Gil-Botella, K. Graczyk, L. Grandi, K. He, J. Holeczek, X. Huang, C. Juszczak, D. Kielczewska, J. Kisiel, L. Knecht, T. Kozlowski, H. Kuna-Ciskal, M. Laffranchi, J. Lagoda, Z. Li, B. Lisowski, F. Lu, J. Ma, M. Markiewicz, F. Mauri, C. Matthey, G. Meng, C. Montanari, S. Muraro, G. Natterer, S. Navas-Concha, G. Nurzia, S. Otwinowski, O. Palamara D. Pascoli, L. Periale, G. Piano Mortari, A. Piazzoli, P. Picchi, F. Pietropaolo, W. Polchlopek, T. Rancati, A. Rappoldi, G.L. Raselli, J. Rico, E. Rondio, M. Rossella, A. Rubbia, C. Rubbia, P. Sala, D. Scannicchio, E. Segreto, Y. Seo, F. Sergiampietri, J. Sobczyk J. Stepaniak, M. Stodulski, M. Szarska, M. Szeptycka, M. Terrani, S. Ventura, C. Vignoli, H. Wang, M. Wojcik, G. Xu, X. Yang, A. Zalewska, J. Zalipska, C. Zhang, Q. Zhang, S. Zhen, W. Zipper.

University and INFN of: L'Aquila, LNF, LNGS, Milano, Padova, Pavia, Pisa - Italy

ETH Hönggerberg, Zürich - Switzerland

CNR Institute of cosmogeophysics, Torino - Italy

University of Silesia, Katowice - Poland

H.Niewodniczanski Inst. of Nucl. Phys., Krakow - Poland

Cracow University of Technology, Krakow - Poland

Warsaw University, Warszawa - Poland

UCLA, Los Angeles - USA

IHEP, Academia Sinica, Beijing - China

Politecnico di Milano - Italy

University of Mining and Metallurgy, Krakow - Poland

Jagellonian University, Krakow - Poland

A.Soltan Inst. for Nucl. Studies, Warszawa - Poland

Wroclaw University, Wroclaw - Poland

This is an “open” collaboration: new teams welcome !

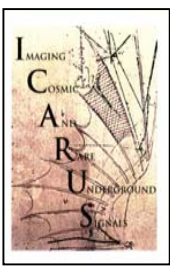

The Icarus Detector

**Large Volume,
liquid Argon TPC**

total mass ~ 3 kTon

**recently approved for
installation in LNGS
Hall B:**

expected date: 2005

**Currently 600 Ton
prototype being
installed at LNGS**

**Results from 300 Ton
module**



Cryostat (half-module)

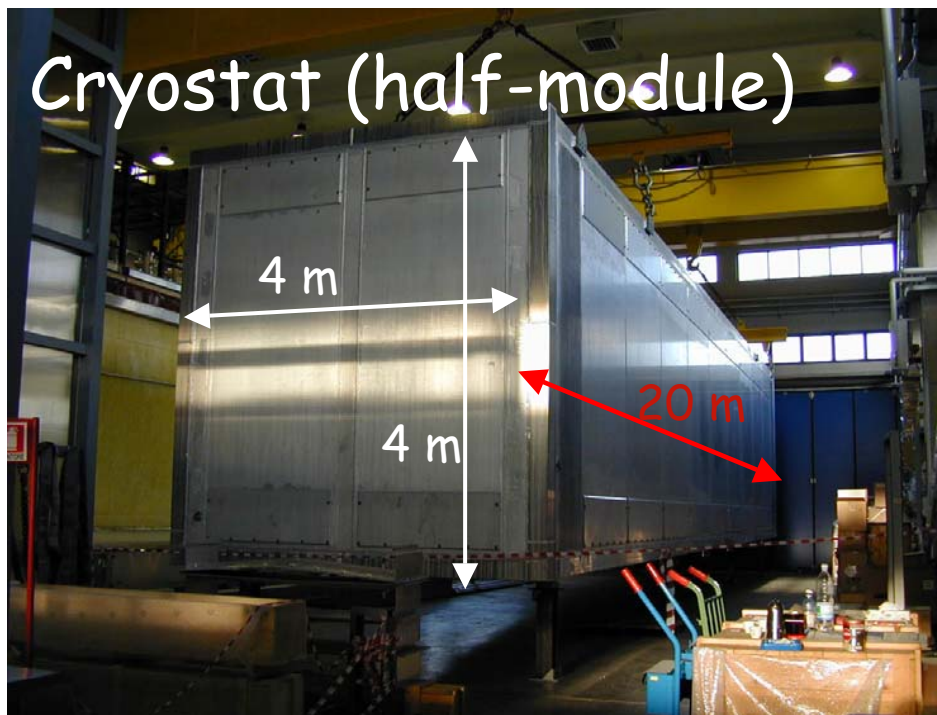

ICARUS T300 prototype

View of the inner detector

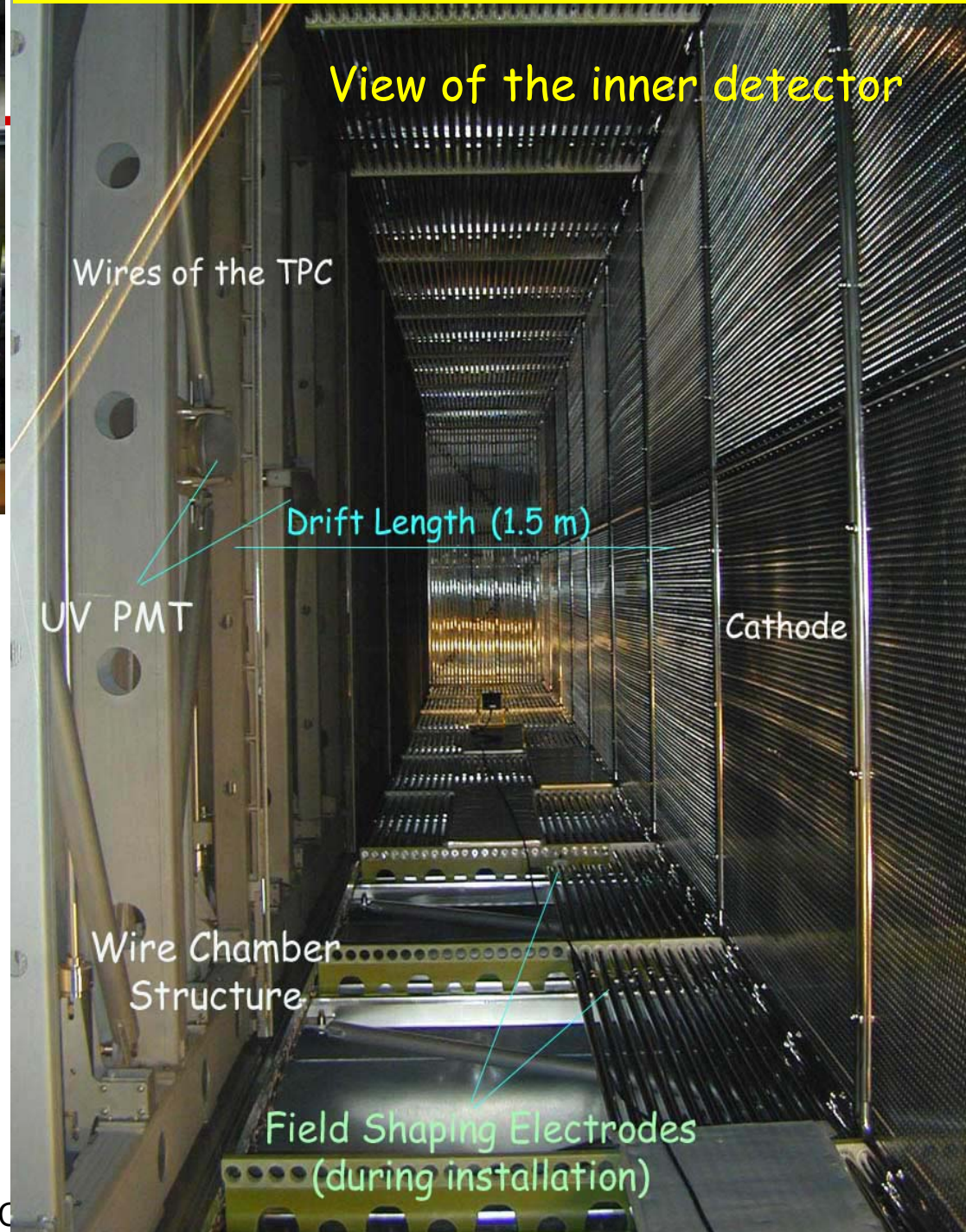

Readout electronics

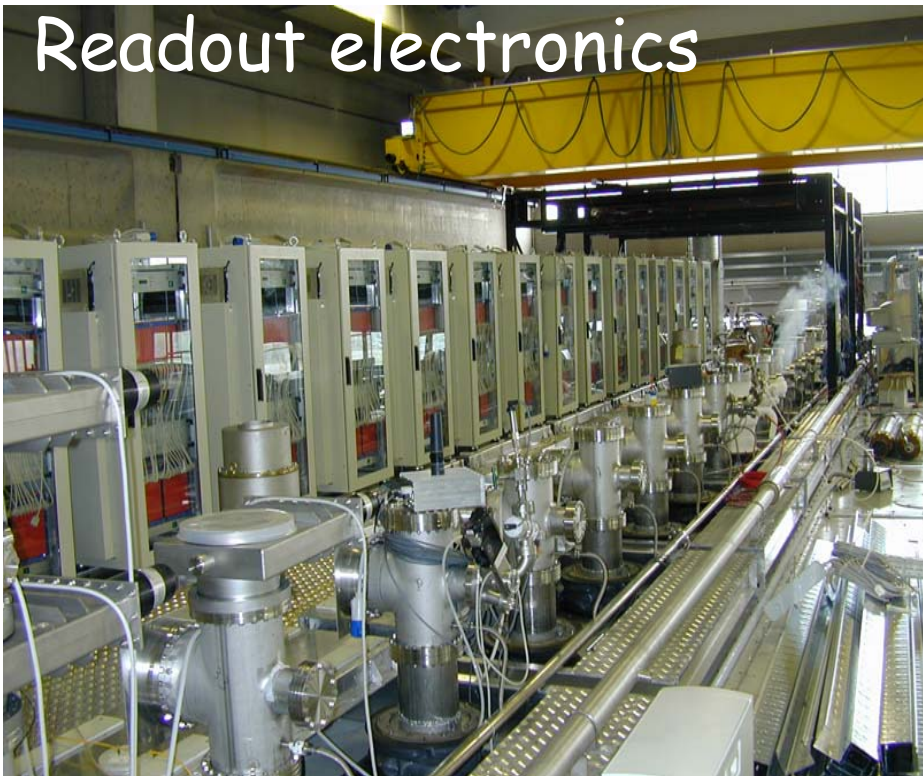

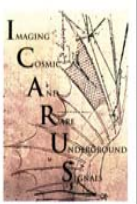

Expected sensitivity to θ_{13}

ICARUS
5 years dedicated SPS
 2.35 kton fid. mass

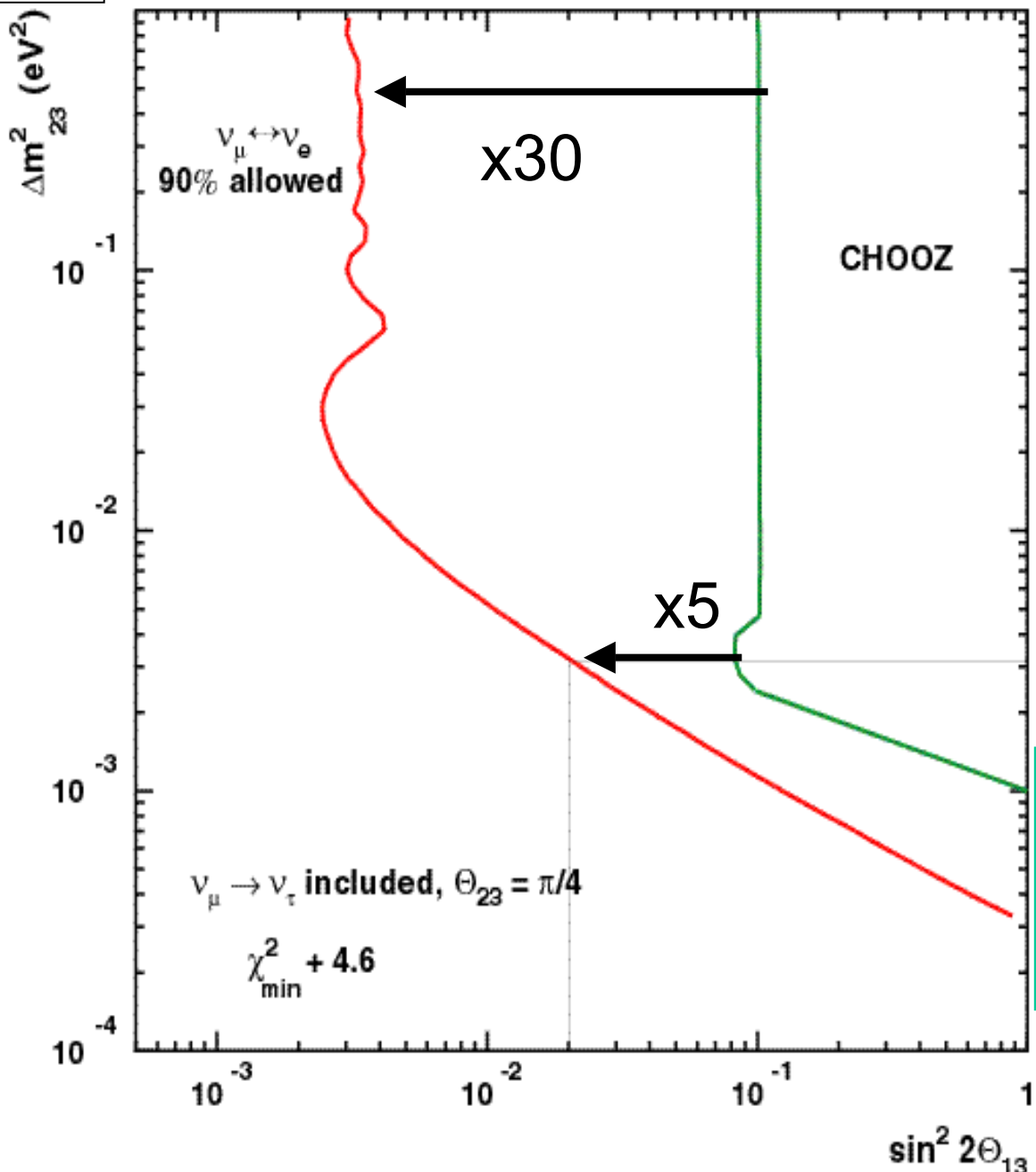

Sensitivity assuming both $\nu_\mu \rightarrow \nu_\tau$ and $\nu_\mu \rightarrow \nu_e$ at the same Δm^2 (three family mixing)

$\sin^2 2\theta_{13} > 2 \times 10^{-2}$
 for $\Delta m_{32}^2 = 3 \times 10^{-3} eV^2$

Θ_{13} limit from 9 to 50

Long Baseline Experiments: The Next Generation

- Geared toward observation of $\nu_\mu \rightarrow \nu_e$ at Δm^2_{atm}
- Off-Axis (2°) CNGS beam to off-shore detector
 - Under-water $\bar{\nu}_\mu$ detector 1200 km from CERN in G. of Taranto
 - Low energy beam config. @ 0.8 GeV (2^{nd} osc. max.)
 - EOI: <http://home.cern.ch/dydak/oscexp.ps>
- Off-Axis ($0.5\text{-}1^\circ$) NuMI beam to surface detector
 - sites in Minnesota ($\sim 700+$ km) & Canada (~ 900 km) possible
 - 20 kTon detector, possibly H₂O, possibly RPC, possibly scint.
 - Sensitivity to θ_{13} at 1.5×10^{-3} level
 - LOI (Fermilab P929):
http://www-numi.fnal.gov/fnal_minos/new_initiatives/
 - Note: 1-Day meeting at UC London, Monday September 16

Long Baseline Experiments: More Ideas for future

- BNL beams to NUSL, Upstate NY, Soudan...
 - Upgrades to AGS: 0.5 – 1.3 MW
 - Letter of Intent: [hep-ex/0205040](#)
- CERN beam to Frejus
 - New low-energy proton synchrotron (2 GeV) re-using LEP RF
 - 300 MeV neutrino energy, H₂O detector
- “Beta-Beam” to Frejus
 - ν_e and $\bar{\nu}_e$ from accelerated ^{18}Ne and ^6He ions
 - 300 MeV neutrino energy, H₂O detector
- Krasnoyarsk reactor experiment – ν_e disappearance
 - Improve on Chooz sensitivity by factor of ~8
- Haven't mentioned FNAL proton driver, or ν factories

Summary



– Exciting time for Long Baseline experiments

- MINOS construction far along— first look at cosmics
- Significant progress in CNGS program
- Interesting ideas for next generation:
 - **NuMI off-axis, CNGS off-axis, BNL beams, beta beams...**

– Far future will depend on what current and next generation exp'ts turn up!

- If θ_{13} is not so small, possibility of seeing CP violation will be too good to pass up.
- This will require a significant international project

Backup Slides

Near Detector Assembly

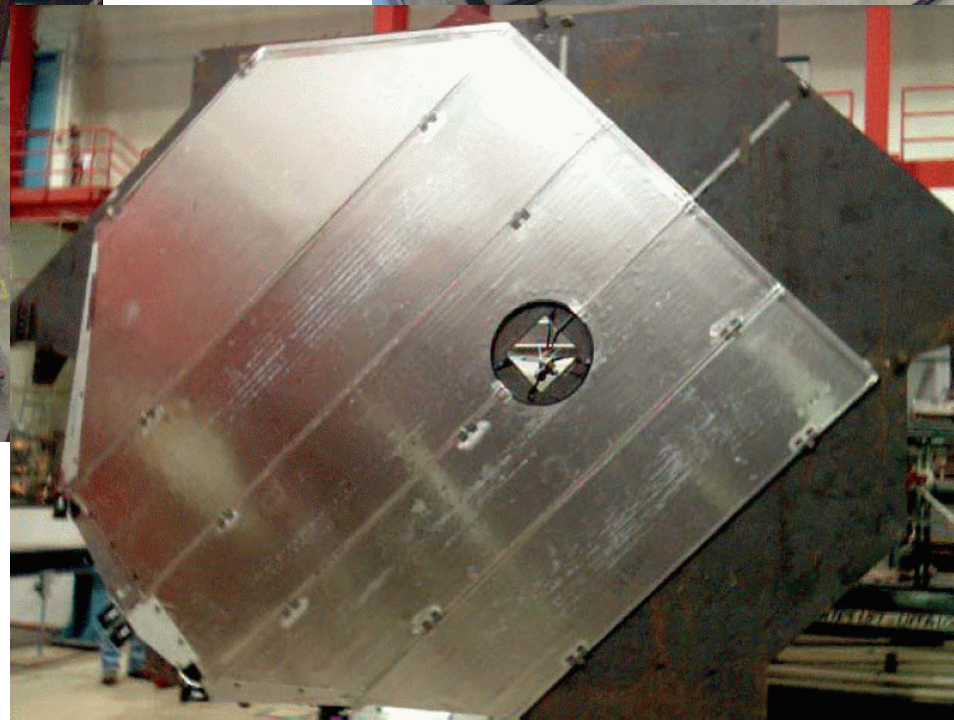

Calibration Detector

