



***Status report on the GLACIER project***

**Andreas Badertscher (ETH Zürich)**

**International Neutrino Factory And Superbeam Scoping Study  
Meeting, KEK - 22-25 January 2006**

## Introduction

- Within the ICARUS program, the concept of large cryogenic detectors based on noble liquids (Argon and Xenon) have been developed for many years. In such detectors, ionisation electrons are used to create an “image” of the tracks of the particles. Scintillation light may be used to trigger the event.
- A series of several modules of different sizes have been operated, in which all the basic features of ionisation, long electron drift and scintillation in liquid Argon have been systematically studied for a variety of incident particles. The largest detector ever built has a mass of 600 tons being installed at Gran Sasso.
- This talk is on our conceptual design of a scalable liquid Argon TPC which could be possibly magnetized. We report on the status of the project and of the on-going R&D activities. More details in:
  - Experiments for CP violation: a giant liquid Argon scintillation, Cerenkov and charge imaging experiment, A.Rubbia, Proc. II Int. Workshop on Neutrinos in Venice, 2003, Italy, hep-ph/0402110
  - Ideas for future liquid Argon detectors, A. Ereditato and A.Rubbia, Proc. Third International Workshop on Neutrino-Nucleus Interactions in the Few GeV Region, NUINT04, March 2004, Gran Sasso, Italy, Nucl.Phys.Proc.Suppl. 139:301-310, 2005, hep-ex/0409034
  - Ideas for a next generation liquid Argon TPC detector for neutrino physics and nucleon decay searches, A. Ereditato and A.Rubbia, Proc. Workshop on Physics with a Multi-MW proton source, May 2004, CERN, Switzerland, submitted to SPSC Villars session
  - Very massive underground detectors for proton decay searches, A.Rubbia, Proc. XI Int. Conf. on Calorimetry in H.E.P., CALOR04, Perugia, Italy, March 2004, hep-ph/0407297
  - Liquid Argon TPC: mid & long term strategy and on-going R&D, A.Rubbia, Proc. Int. Conf. on NF and Superbeam, NUFACT04, Osaka, Japan, July 2004
  - Liquid Argon TPC: a powerful detector for future neutrino experiments, A.Ereditato and A. Rubbia, HIF05, La Biodola, Italy, May 2005, hep-ph/0509022
  - Neutrino detectors for future experiments, A.Rubbia, Nucl. Phys. B (Proc. Suppl.) 147 (2005) 103.
  - Conceptual Design of a scalable multi-kton superconducting magnetized liquid argon TPC, A. Ereditato and A. Rubbia, hep-ph/0510131.

# The Liquid Argon TPC principle

Charge yield  $\sim 6000$  electrons/mm  
( $\sim 1$  fC/mm)

Charge readout planes: Q

UV Scintillation Light: L

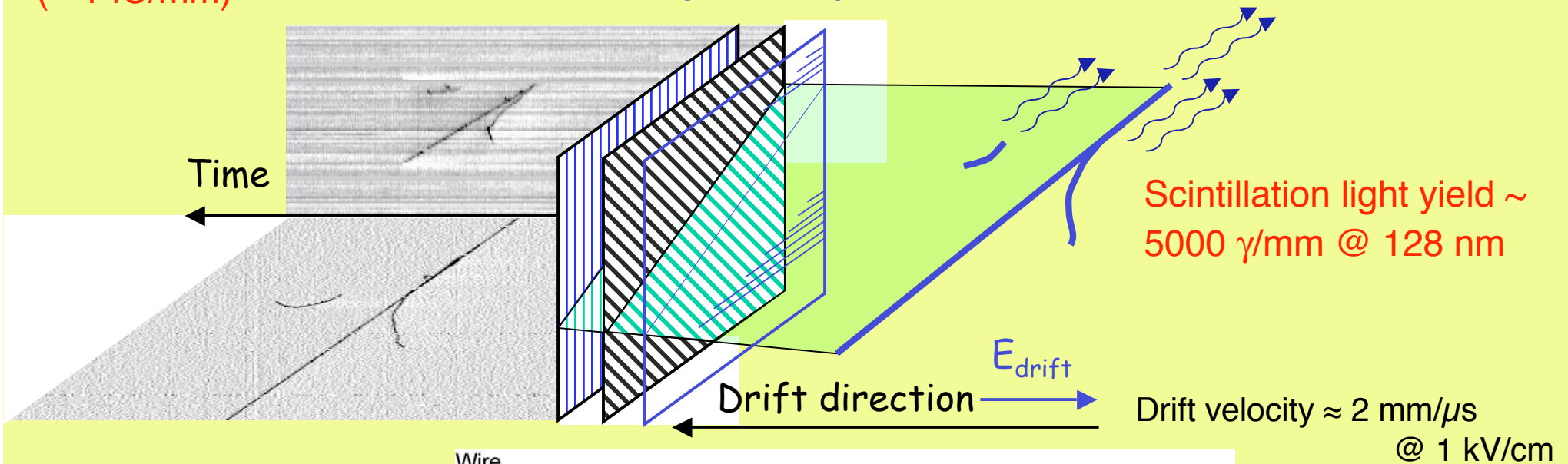

Drift electron lifetime:

$$\tau \approx 300\mu\text{s} \times \frac{1\text{ppb}}{N(\text{O}_2)}$$

Purity  $< 0.1$ ppb  $\text{O}_2$ -equiv.

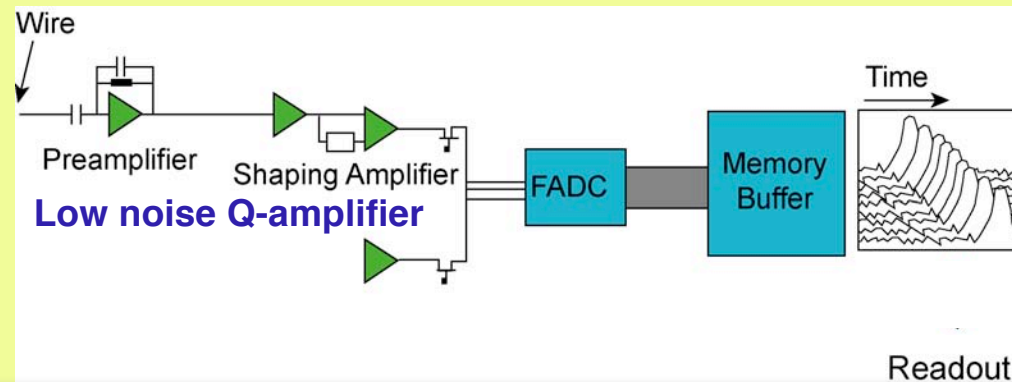

Continuous  
waveform recording  
→ image

- The Liquid Argon Time Projection Chamber: a new concept for Neutrino Detector, C. Rubbia, CERN-EP/77-08 (1977).
- A study of ionization electrons drifting large distances in liquid and solid Argon, E. Aprile, K.L. Giboni and C. Rubbia, NIM A251 (1985) 62.
- A 3 ton liquid Argon Time Projection Chamber, ICARUS Collab., NIM A332 (1993) 395.
- Performance of a 3 ton liquid Argon Time Projection Chamber, ICARUS Collab., NIM A345 (1994) 230.
- The ICARUS 50 l Lar TPC in the CERN neutrino beam, ICARUS Collab, hep-ex/9812006 (1998).

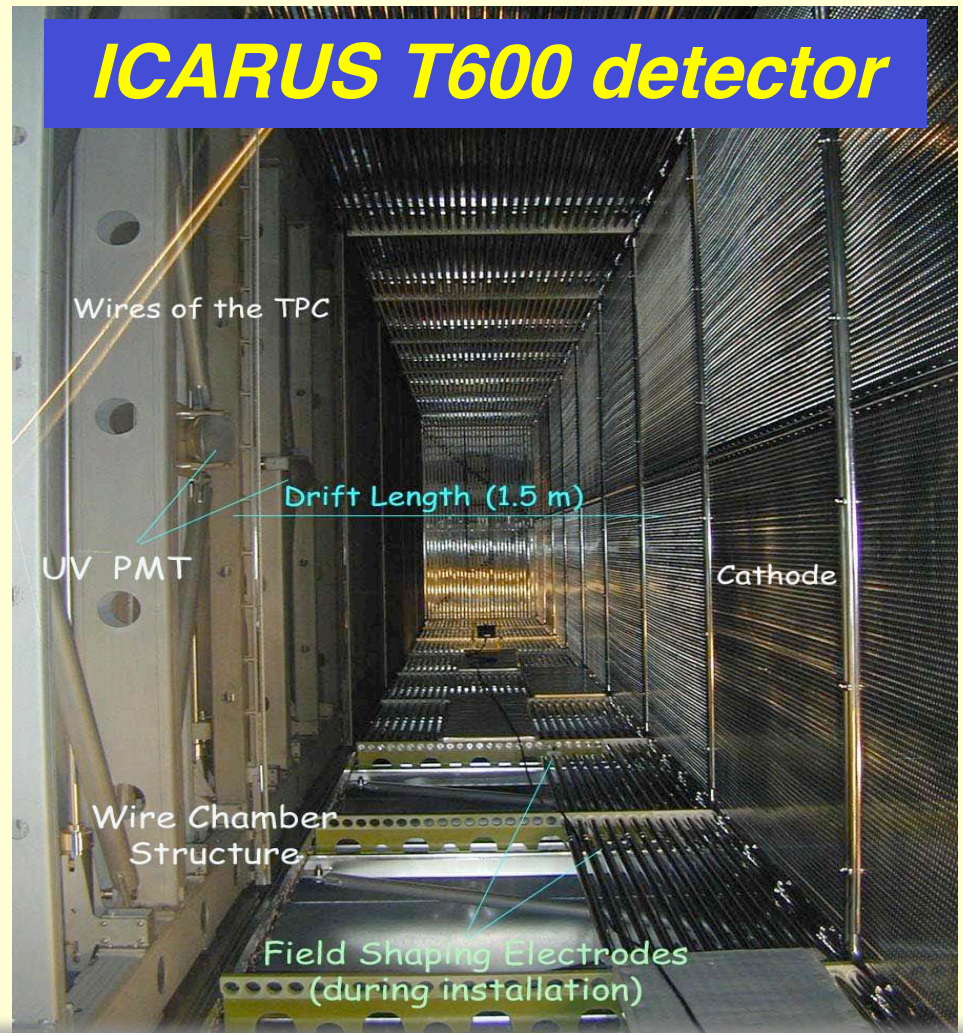
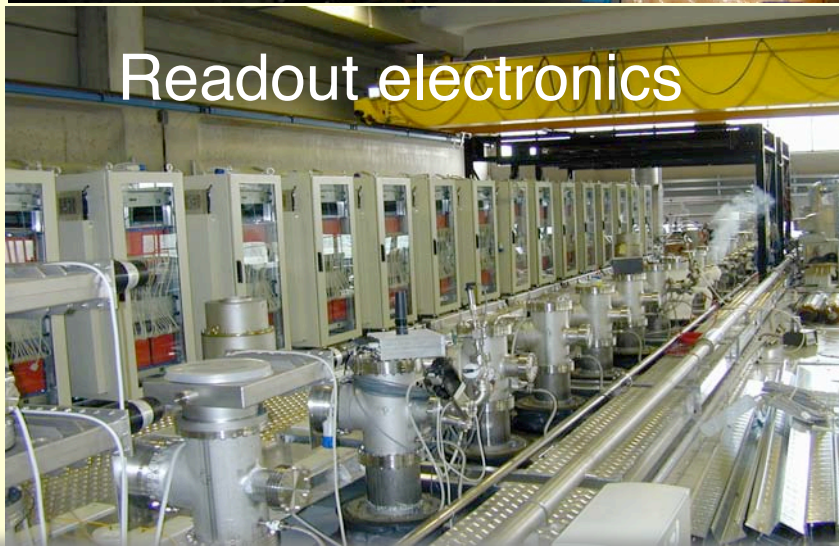
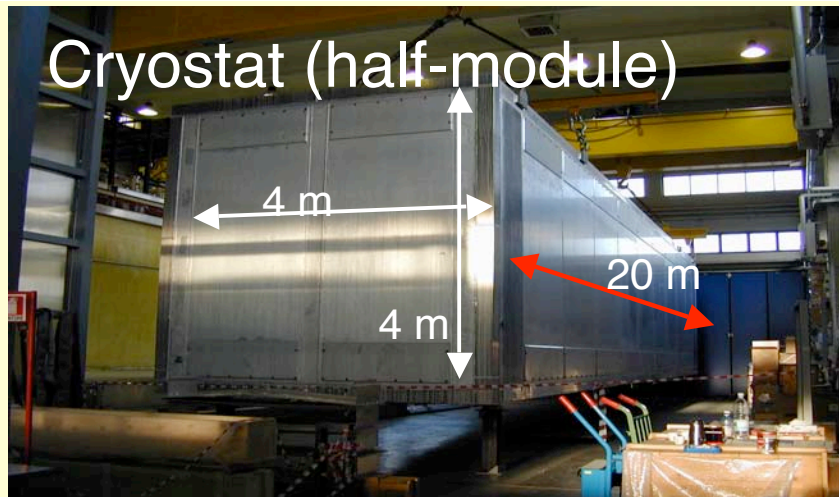

- Design, construction and tests of the ICARUS T600 detector, ICARUS Collab, NIM A527 329 (2004).
- Study of electron recombination in liquid Argon with the ICARUS TPC, ICARUS Collab, NIMA523 275-286 (2004).
- Detection of Cerenkov light emission in liquid Argon, ICARUS Collab, NIM A516 348-363 (2004).
- Analysis of the liquid Argon purity in the ICARUS T600 TPC, ICARUS Collab, NIM A516 68-79 (2004).
- Observation of long ionizing tracks with the ICARUS T600 first half module, ICARUS Collab, NIM A508 287 (2003).
- Measurement of the muon decay spectrum with the ICARUS liquid Argon TPC, ICARUS Collab, EPJ C33 233-241 (2004).

# Neutrino detectors for future experiments: the choice of technologies

Detector	Mass kt	Solar	SN	Atm	Nucleon decay	Superbeam, $\beta$ -beam			$\nu$ -factory 10's GeV
						subGeV	GeV	10's GeV	
WC	$\simeq 1000$	$\approx$	yes	yes	yes	yes	$\approx$	no	no
LAr	$\simeq 100$	yes	yes	yes	yes	yes	yes	yes	yes ( $\mu$ -catcher)
Magnetized LAr	$\simeq 25$	yes	yes	yes	yes	yes	yes	yes	$e^\pm, \mu^\pm, \tau^\pm$
Magnetized sampling Cal.	$\simeq 50$	no	no	$\mu^\pm$	no	$\approx$	yes	yes	$\mu^\pm$
Non-magnetized sampling Cal.	$\simeq 50$	no	no	$\mu$ 's	no	$\approx$	yes	yes	no
Emulsion hybrid	$\simeq 1$	no	no	no	no	no	$\approx$	yes	$\tau^\pm$

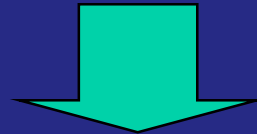

The liquid Argon TPC has the capability to provide truly multi-purpose detectors to reach a broad and comprehensive physics program.

With a magnetized LAr TPC it is possible to directly consider both CP (“**golden**”) and T-violation (“**platinum?**”) searches at a NF. In addition, the “**silver**” mode might kinematically be accessible.

Concept:

The Giant Liquid Argon Charge  
Imaging Experiment  
(GLACIER)

# ***GLACIER working group***

**ETHZ (Switzerland):**

A. Badertscher, L. Knecht, M. Laffranchi, A. Meregaglia,  
M. Messina, G. Natterer, P. Otiougova, A. Rubbia, J. Ulbricht

**Bern University (Switzerland):**

A. Ereditato

**Granada University (Spain):**

A. Bueno, J. Lozano, S. Navas

**INP Krakow (Poland):**

A. Zalewska

**INR Moscow (Russia):**

S. Gninenko

**IPN Lyon (France):**

D. Autiero, Y. Déclais, J. Marteau

**Sheffield University (UK):**

N. Spooner

**Southampton University (UK):**

C. Beduz, Y. Yang

**US Katowice (Poland):**

J. Kisiel

**UPS Warszawa (Poland):**

E. Rondio

**UW Warszawa (Poland):**

D. Kielczewska

**UW Wroclaw (Poland):**

J. Sobczyk

Many thanks to:



**Technodyne Ltd, Eastleigh, UK**



**CUPRUM (KGHM group), Wroclaw, Poland**



**CAEN, Viareggio, Italy**

# *A 100 kton liquid Argon TPC detector*

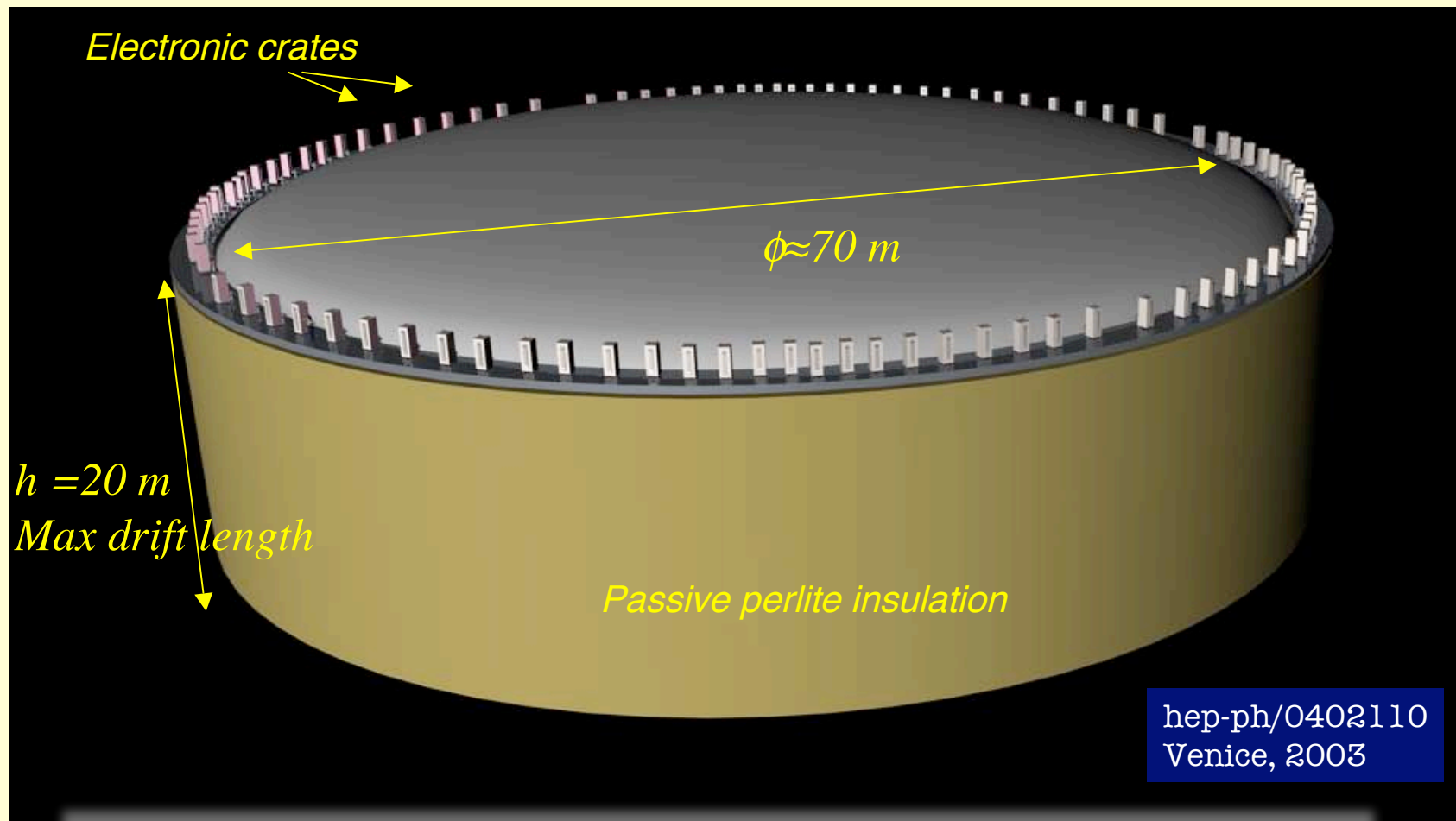

Single module cryo-tanker based on industrial LNG technology

A “general-purpose” detector for superbeams, beta-beams and neutrino factories with broad non-accelerator physics program (SN  $\nu$ , p-decay, atm  $\nu$ , ...)



# Tanker

In Collaboration with industry, we have shown that extrapolation from LNG technology to LAr is possible

**LNG = Liquefied Natural Gas**

## **Cryogenic storage tankers for LNG**



support

*"I learned a lot from the Shell training course. It was detailed, relevant to our business and moved at the right pace"*

An employee, Nigeria LNG

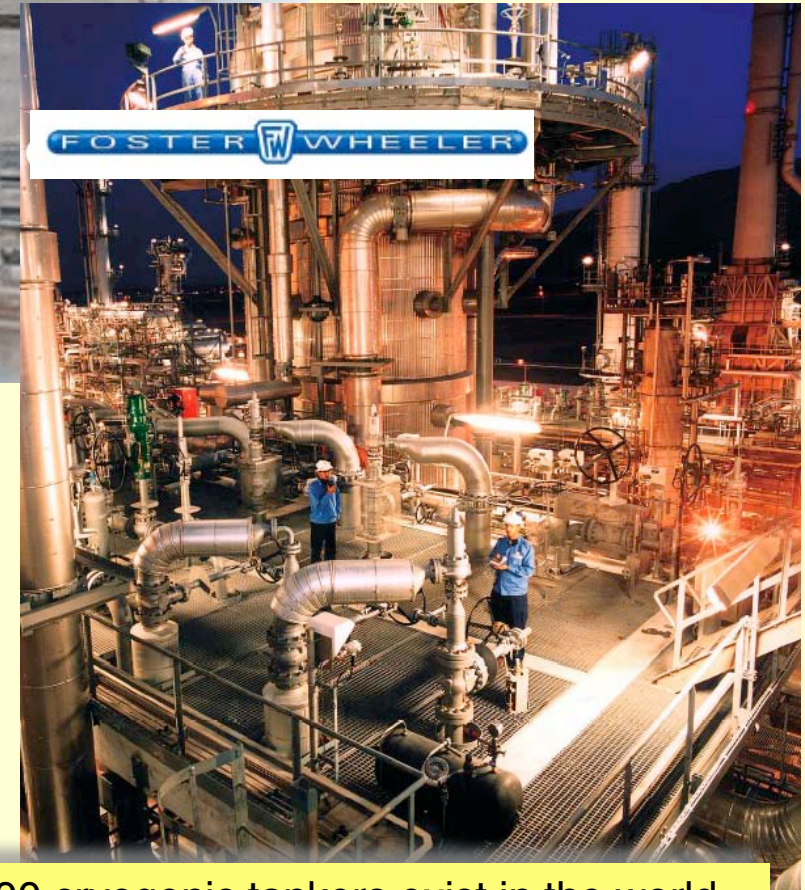

About 2000 cryogenic tankers exist in the world, with volume up to  $\approx 200000 \text{ m}^3$

Process, design and safety issues already solved by petrochemical industry

Cooling by "auto-refrigeration"

# Study of large underground storage tank

	Project: Large <b>Underground</b> Argon Storage Tank
Issued By: JMH	Document Title
Date:	

***A feasibility study  
mandated to  
Technodyne Ltd (UK)***

**Study duration:**

**February - December 2004**

1	<a href="#">Contents</a> .....
2	<a href="#">Introduction</a> .....
3	<a href="#">Requirement</a> .....
4	<a href="#">Tank design</a> .....
4.1	<a href="#">Current LNG Storage Tank Designs</a> .....
4.1.1	<a href="#">Single Containment</a> .....
4.1.2	<a href="#">Double Containment</a> .....
4.1.3	<a href="#">Full Containment</a> .....
4.1.4	<a href="#">Membrane</a> .....
4.2	<a href="#">Underground LAr tank design</a> .....
4.3	<a href="#">Insulation considerations</a> .....
4.4	<a href="#">Construction considerations</a> .....
5	<a href="#">Cavern considerations</a> .....
6	<a href="#">Process considerations</a> .....
6.1	<a href="#">Initial fill</a> .....
6.2	<a href="#">Re-Liquefaction of the boil-off</a> .....
6.3	<a href="#">Purification of the Liquid Argon</a> .....
7	<a href="#">Safety issues</a> .....
7.1	<a href="#">Stability of cavern</a> .....
7.2	<a href="#">Seismic events</a> .....
7.3	<a href="#">Catastrophic failure of inner tank</a> .....
7.4	<a href="#">Argon gas leaks</a> .....
8	<a href="#">Budgetary costing</a> .....
8.1	<a href="#">Tank</a> .....
8.2	<a href="#">Underground cavern</a> .....
8.3	<a href="#">Air Separation Process</a> .....
9	<a href="#">Appendix A SALT CAVERN STABILITY ANALYSIS</a> .....
10	<a href="#">PRELIMINARY CONCLUSIONS</a> .....



# Technodyne baseline design



- The tank consists of the following principal components:
  1. A 1m thick reinforced concrete base platform
  2. Approximately one thousand 600mm diameter 1m high support pillars arranged on a 2m grid. Also included in the support pillar would be a seismic / thermal break.
  3. A 1m thick reinforced concrete tank support sub-base.
  4. An outer tank made from stainless steel, diameter 72.4m. The base of which would be approximately 6mm thick. The sides would range from 48mm thick at the bottom to 8mm thick at the top.
  5. 1500mm of base insulation made from layers of felt and foamglas blocks.
  6. A reinforced concrete ring beam to spread the load of the inner tank walls.
  7. An inner tank made from stainless steel, diameter 70m. The base of which would be approximately 6mm thick and the sides would range from 48mm thick at the bottom to 8mm thick at the top.
  8. A domed roof with a construction radius of 72.4m attached to the outer tank
  9. A suspended deck over the inner tank to support the top-level instrumentation and insulation. This suspended deck will be slightly stronger than the standard designs to accommodate the physics instrumentation. This in turn will apply greater loads to the roof, which may have to be strengthened, however this is mitigated to some extent by the absence of wind loading that would be experienced in the above ground case.
  10. Side insulation consisting of a resilient layer and perlite fill, total thickness 1.2m.
  11. Top insulation consisting of layers of fibreglass to a thickness of approximately 1.2m.

# Insulation considerations



- Based upon current industry LNG tank technology, Technodyne have designed the tank with 1.5 m thick load bearing Foamglas under the bottom of the tank, 1.2 m thick perlite/resilient blanket on the sides and 1.2m thick fibreglass on the suspended deck. Assuming that the air space is supplied with forced air at 35 degrees centigrade then the boil off would be in the order of 29m<sup>3</sup> LAr per day. **This corresponds to 0.039% of total volume per day.**

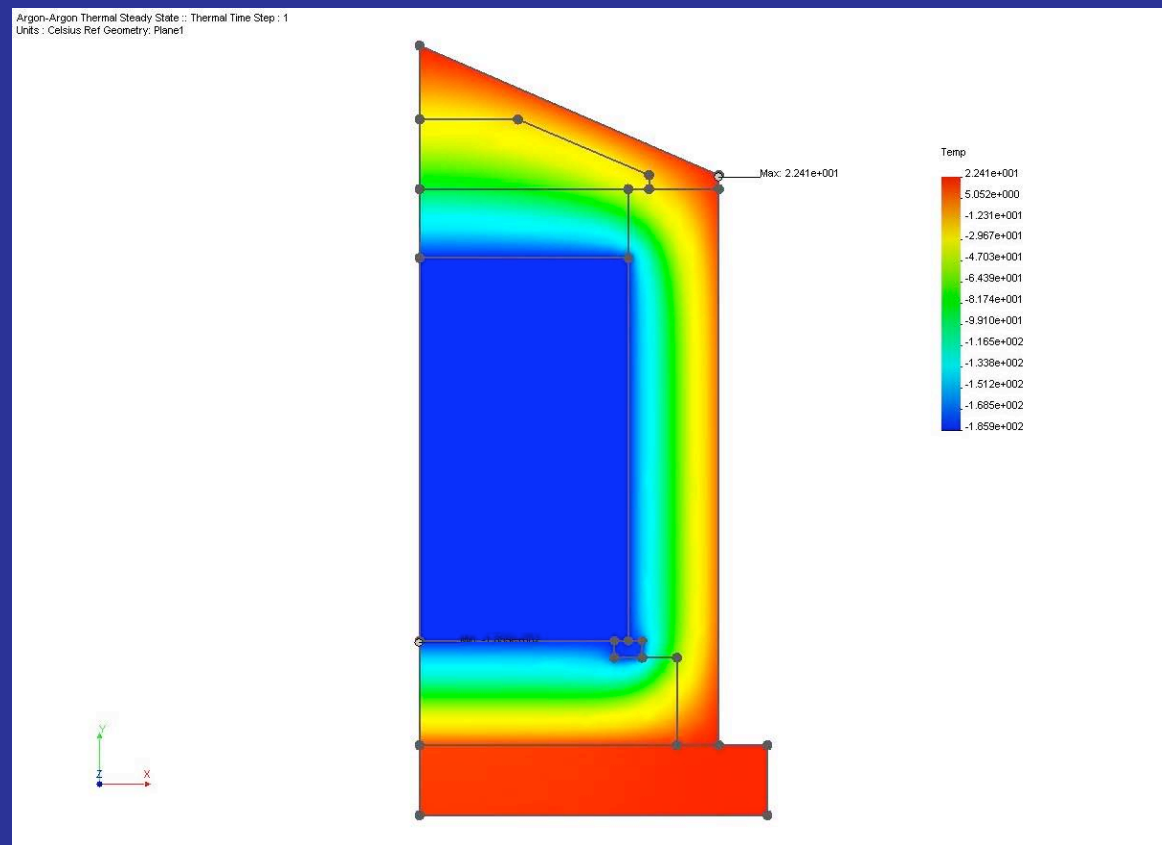

# Tank safety issues

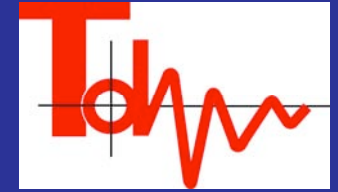

- **1.1 Stability of cavern**

- ↳ The assessment of the stability of a large cavern must be considered. When designing cryogenic tanks for above ground factors such as wind loading and seismic effects are taken into account, however large rock falls are not. The structure in a working mine are well understood by the mining engineers.

- **1.2 Seismic events**

- ↳ Consideration of seismic events must be given to both the cavern and the tank. The tank design codes require an assessment of performance at two levels of seismic event corresponding to a 500 year and a 10,000 year return period. The design procedure will require a geo-technical Seismic Hazard Assessment study which will establish design ground accelerations. The tanks can normally be successfully designed to withstand quite severe seismic events.

- **1.3 Catastrophic failure of inner tank**

- ↳ In spite of the recent large rise in LNG tank population, there has been no failure of an LNG tank built to recent codes, materials and quality standards. Catastrophic failure is now discounted as a mode of failure.

- **1.4 Argon gas leaks**

- ↳ According to the most complete source of refrigerated tank failures, there have been 16 leaks from refrigerated storage tanks during the period 1965 to 1995. Using this value, an overall leak frequency can be calculated to be  $2.0 \times 10^{-4}$  per tank year. Measures must be put in place to mitigate the effects of an Argon Gas leak. The force ventilation system required for the insulation system will do this.

# A dream come true?

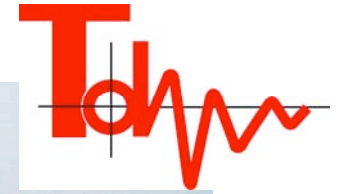

**(1) Concrete base**



**(2) Concrete outer-shell**

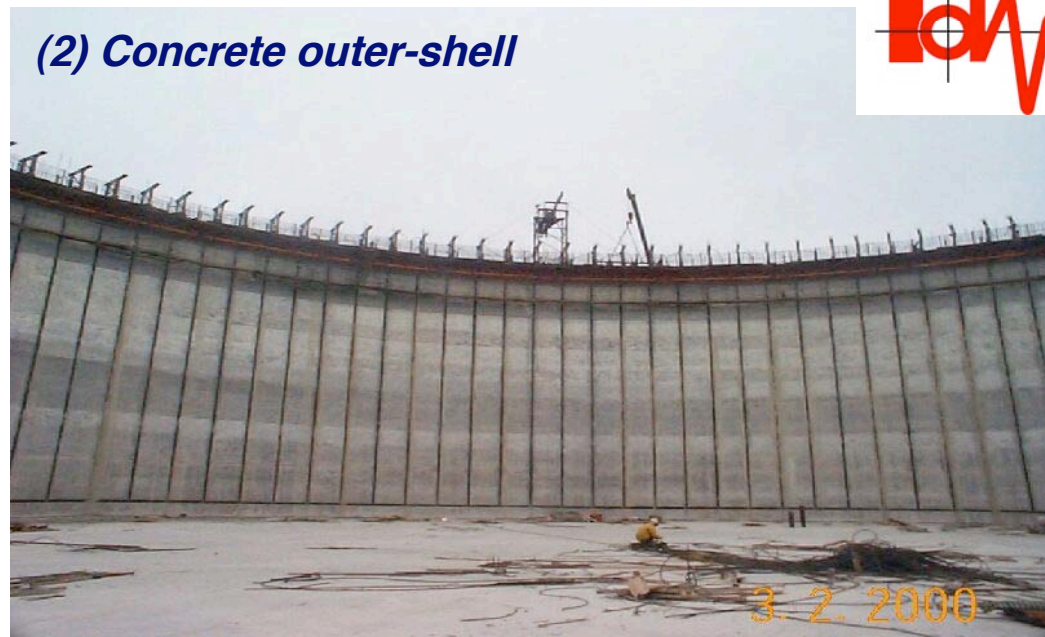

**(3) Roof assembly**



**(4) Air-raising**

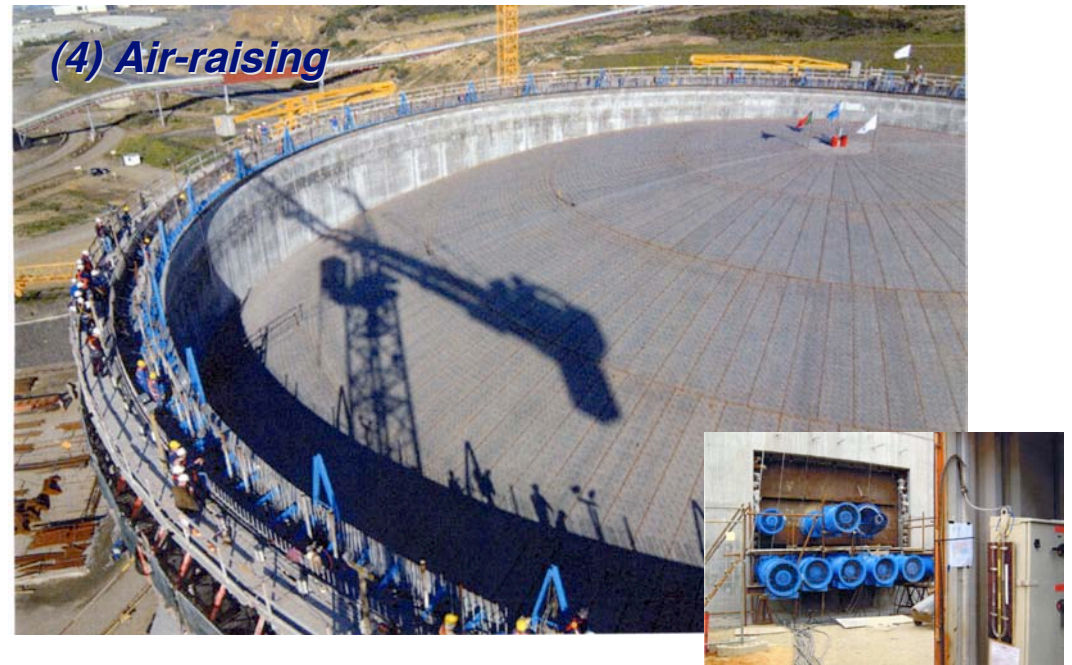



## *(5) Roof welding*

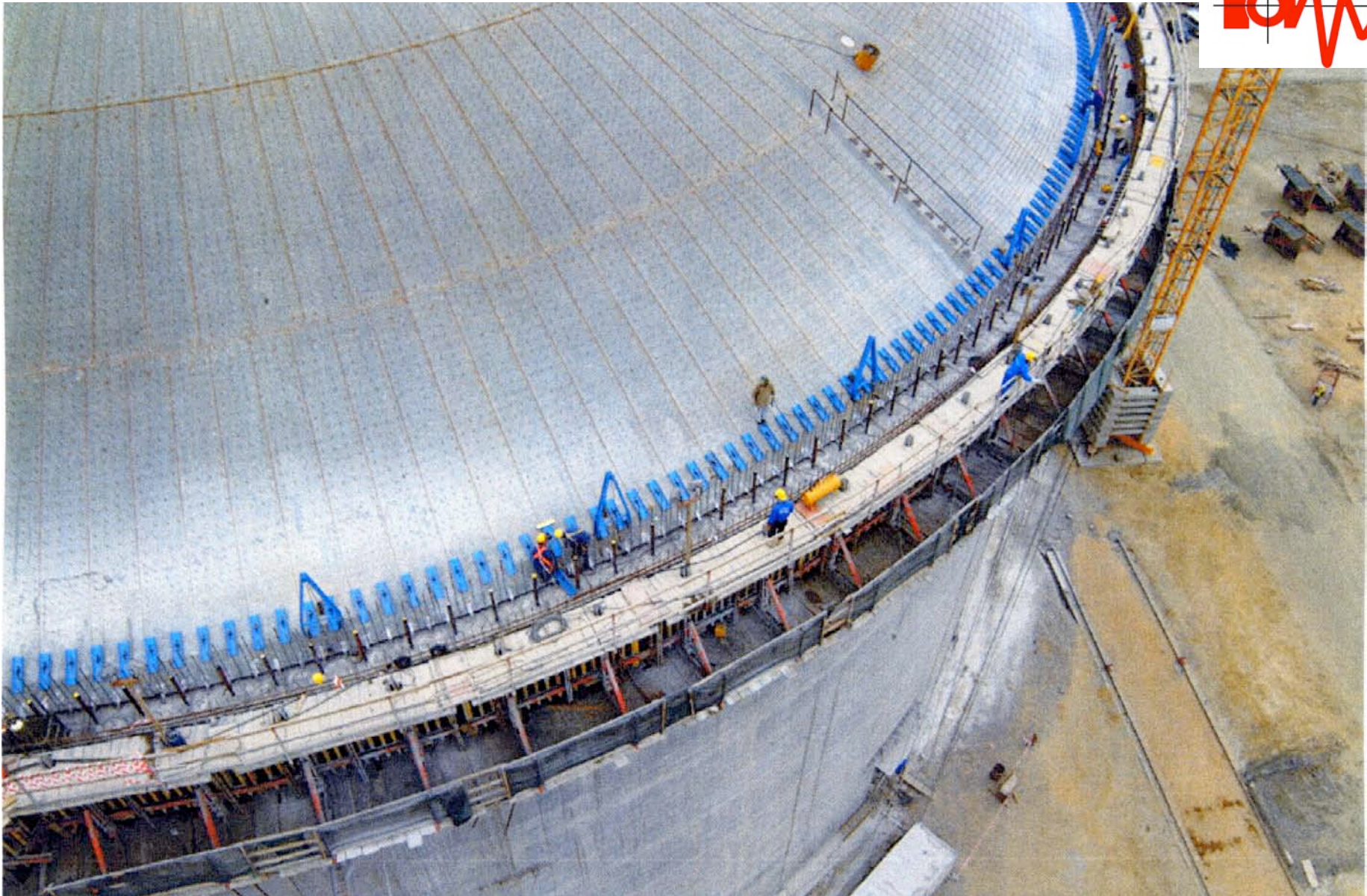

# Process system & equipment

- Filling speed (100 kton): 150 ton/day  $\rightarrow$  2 years to fill
- Initial LAr filling: decide most convenient approach: transport LAr and/or in situ cryogenic plant
- Tanker 5 W/m<sup>2</sup> heat input, continuous re-circulation (purity)
- Boiling-off volume at regime:  $\approx$ 45 ton/day ( $\approx$ 10 years to evaporate entire volume)

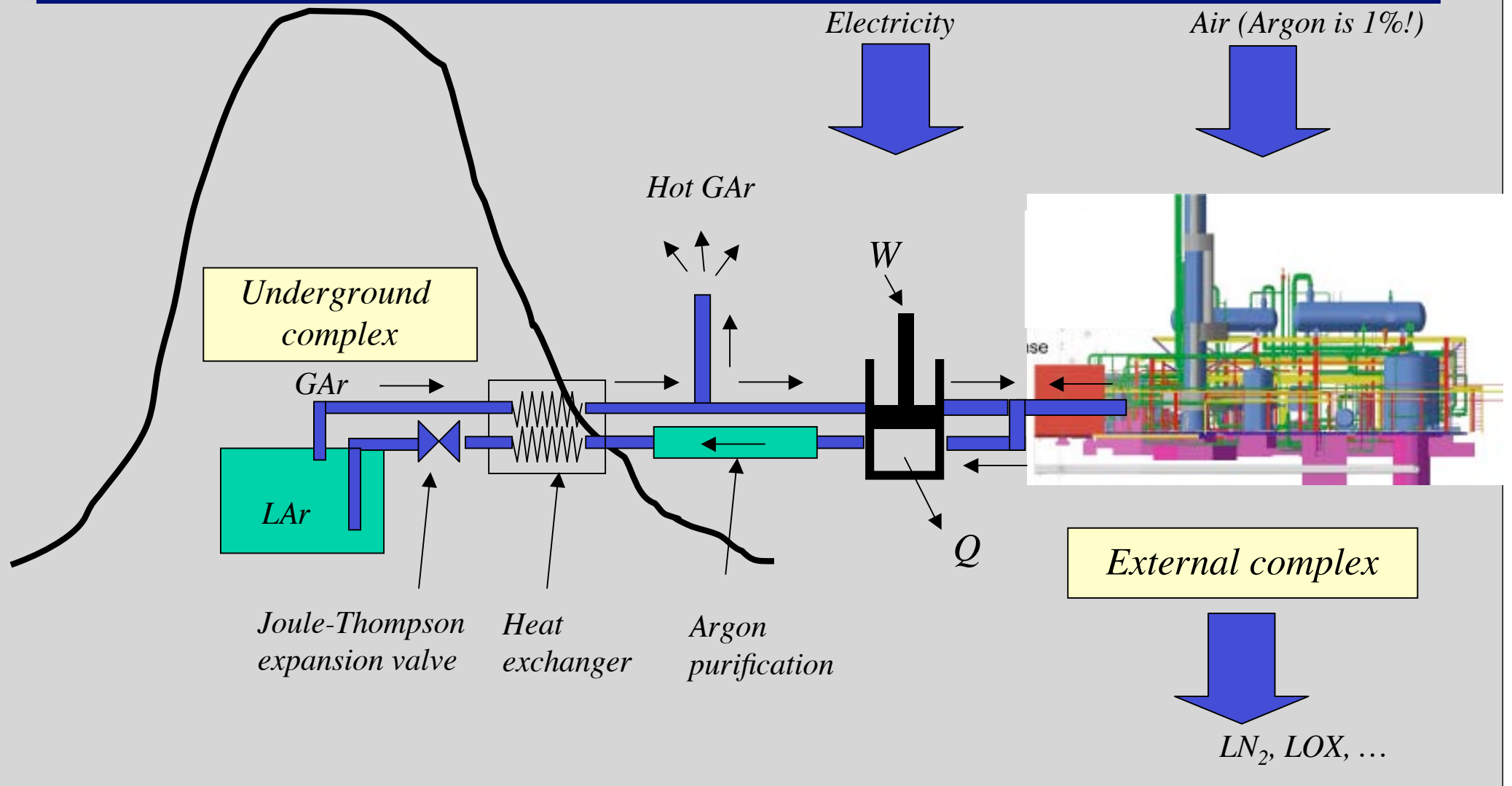

# Process considerations

- There are three major items required for generating and maintaining the Liquid Argon needed in the tank. These are:
  - Filling the tank with the initial Liquid Argon bulk
  - Re- liquefaction of the gaseous Argon boil-off.
  - Continuous purification of the Liquid Argon.
- 1.1 *Initial fill*
  - The requirements for the initial fill are large, corresponding to 150 tonnes of Liquid Argon per day over two years. Argon is a by product of the air separation plant which is usually aimed at a certain amount of oxygen production per day. The amount required is a significant proportion of the current European capacity. Hence new investment will be required by the industry to meet the project requirement. This could either be a specific plant located for the project or increases in capacity to several plants in the area. British Oxygen's largest air separation plant in Poland has the capability to produce 50 Tonnes of Liquid Argon per day. However, this is nearly all supplied to industry and therefore the available excess for a project of this size would be relatively small.
  - A typical air separation plant producing 2000 tonnes per day of Oxygen would produce 90 tonnes per day of Liquid Argon. This facility would have a 50-60 metre high column, would need approximately 30m x 40m of real-estate, would need 30-35MW of power and cost 45 million euros. Energy to fill would cost ≈25MEuro.
  - Purchasing LAr costs would be in the region of 500 euros per tonne. Transportation costs are mainly dependant upon the cost of fuel and the number of kilometres between supply and site. To fill the tank would require 4500 trips of 25 tons trucks and would cost ≈30 million euros for transport.

# Process considerations

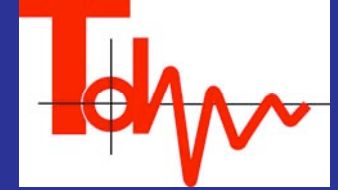

## ● 1.2 *Cooldown*

- ➔ Assuming a start temperature of 35 degrees C and using Liquid Argon to perform the cool-down then the amount of liquid Argon required for the cool-down process would be  $\approx 1000$  tonnes LAr. Assuming that the liquefaction plant can produce 150 tonnes / day of liquid argon then the cool-down process would take 7 days.

## ● 1.3 *Re-Liquefaction of the boil-off*

- ➔ The Technodyne design of the tank assumes that an adequate supply of air is circulated around the tank to prevent the local rock / salt from freezing, thereby reducing the risk of rock movement or fracture. For an air temperature of 35 degrees (constant throughout a 24 hour period) the boil off of Liquid argon would be in the region of 29000 litres per day. This would require  $\approx 10$  MW of power.
- ➔ Alternatively a compression system can take the boil off gas and re-compress, filter and then re-supply to the tank. The power is likely to be a similar order of magnitude of 8 MW.

## ● 1.4 *Purification of the Liquid Argon*

- ➔ The Liquid Argon should be as pure as possible, the required target impurities being less than 0.1 ppb. To achieve this argon must be re-circulated through a filter system to remove impurities. The requirement is to re-circulate all the LAr in a period of 3 months. This equates to  $33\text{m}^3$  / hour. The use of Messer- Griesheim filters suggests that a flow of 500 l / hour is possible through a standard hydrosorb / oxysorb filter. This would equate to a requirement for a minimum of 67 filters to achieve the required flow rate.

# Detector layout

A “straight-forward” scalable  
detector layout

# A tentative detector layout

Single detector: charge imaging, scintillation, possibly Cerenkov light

Dewar	$\phi \approx 70$ m, height $\approx 20$ m, perlite insulated, heat input $\approx 5$ W/m <sup>2</sup>
Argon storage	Boiling Argon, low pressure (<100 mbar overpressure)
Argon total volume	73000 m <sup>3</sup> , ratio area/volume $\approx 15\%$
Argon total mass	102000 tons
Hydrostatic pressure at bottom	3 atmospheres
Inner detector dimensions	Disc $\phi \approx 70$ m located in gas phase above liquid phase
Charge readout electronics	100000 channels, 100 racks on top of the dewar
Scintillation light readout	Yes (also for triggering), 1000 immersed 8" PMTs with WLS
Visible light readout	Yes (Cerenkov light), 27000 immersed 8" PMTs of 20% coverage, single $\gamma$ counting capability

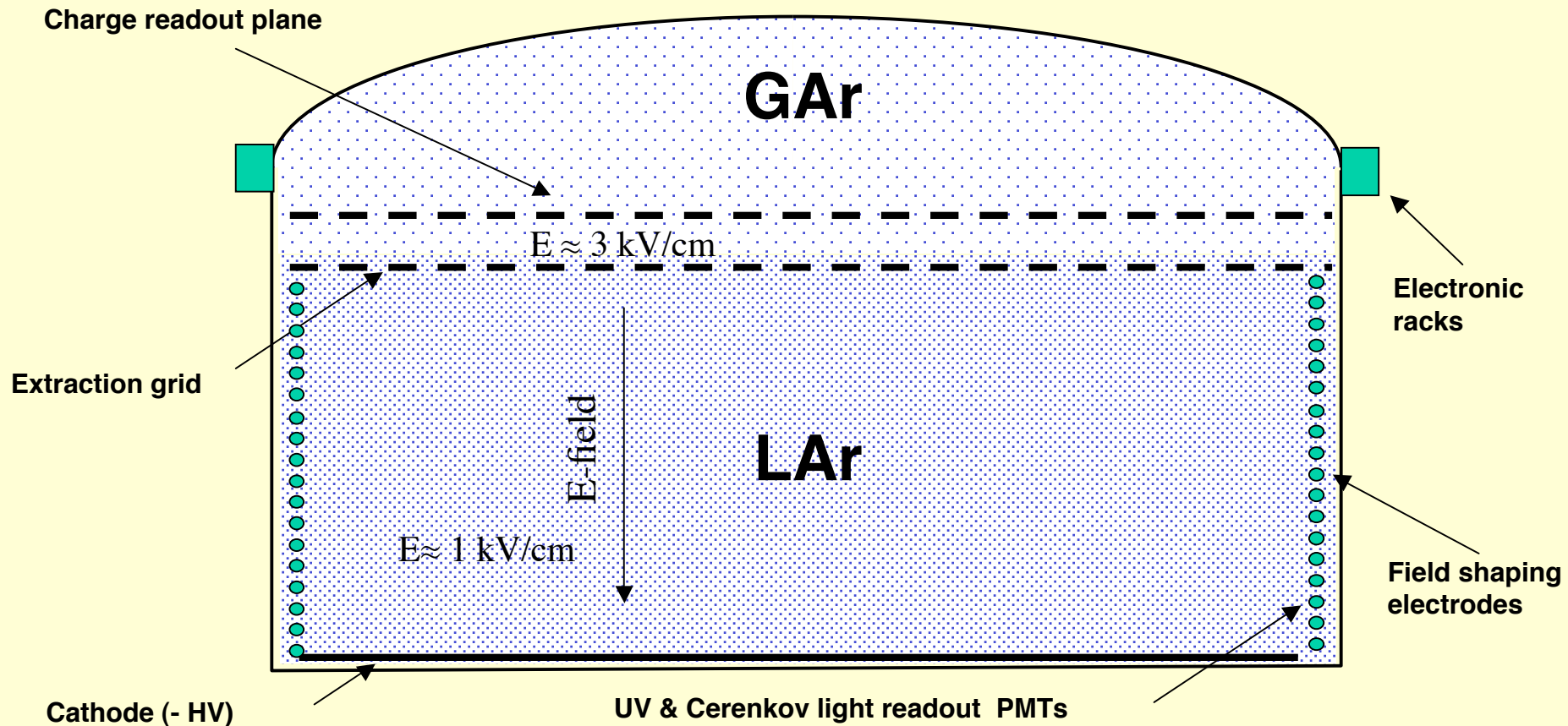

# Charge extraction, amplification, readout

A new method for readout to allow for a very long drift path, potentially cheaper electronics and avoid use of readout wires

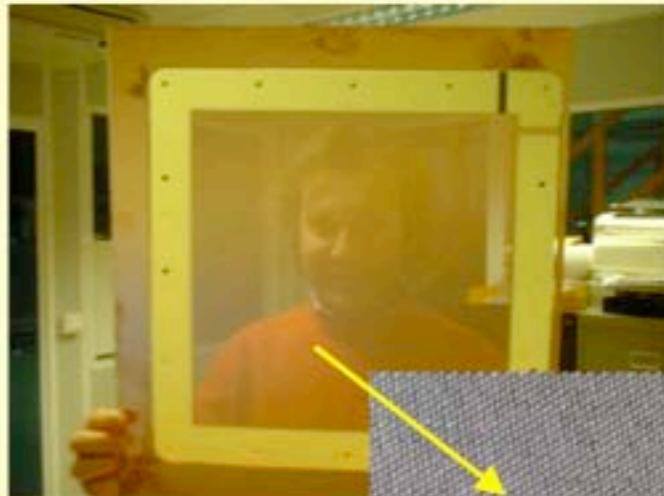

- Thick-LEM (vetronite Cu coated + holes): sort of macroscopic GEM. Easier to operate at cryogenic temperature.

- On application of a difference of potential between the two electrodes, electrons on one side of the structure drift into the holes, multiply and transfer to a collection region.

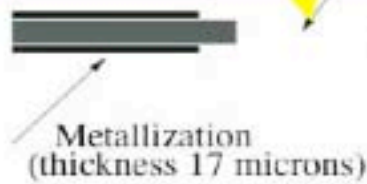
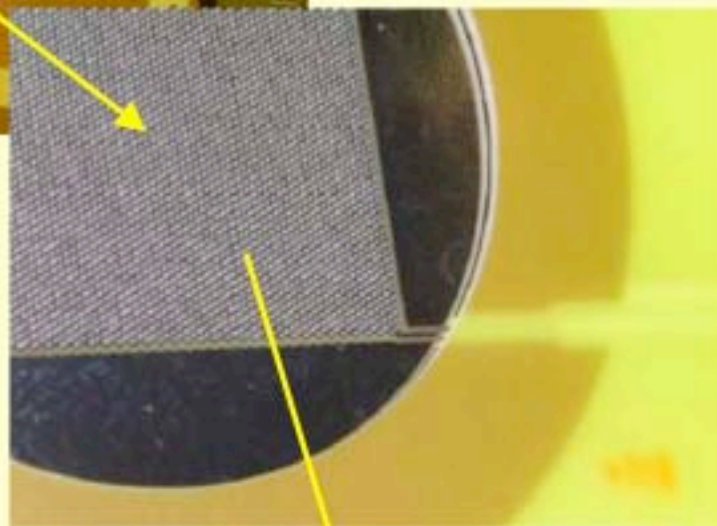

Thick-LEM

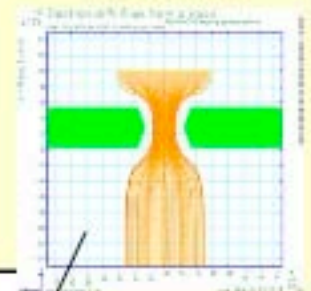

E.g. wires

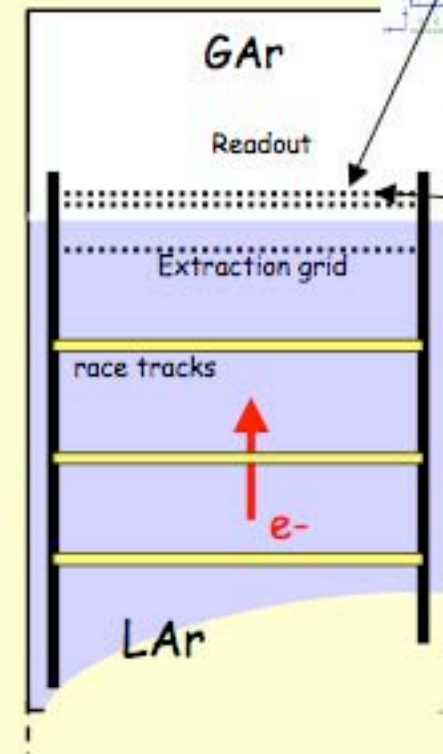
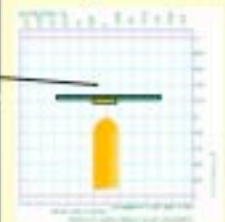

# High gain operation of LEM in pure Ar at high pressure

- Fe-55 & Cd-109 sources, Argon 100%
- Varying pressures (from 1 bar up to 3.5 bar)
- Room temperature
- Drift field  $\approx 100\text{V/cm}$  (100% transparency)

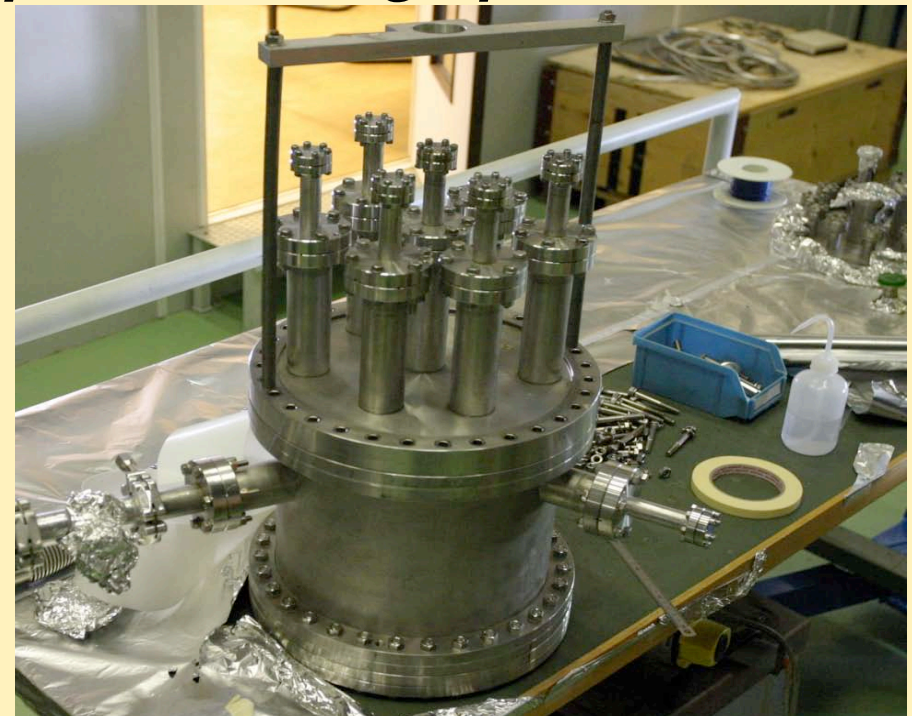

pedestal

5.7 keV

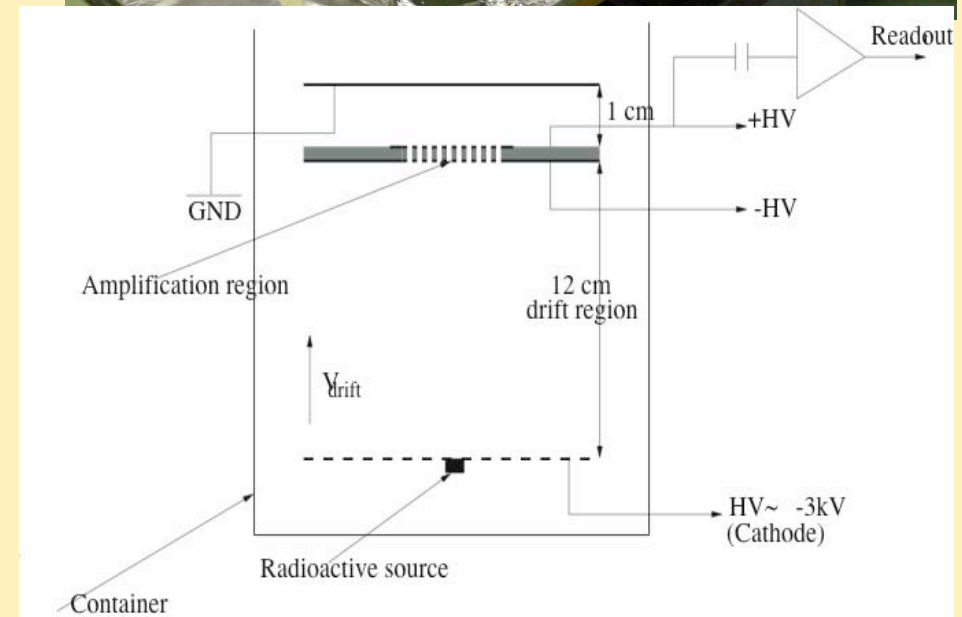
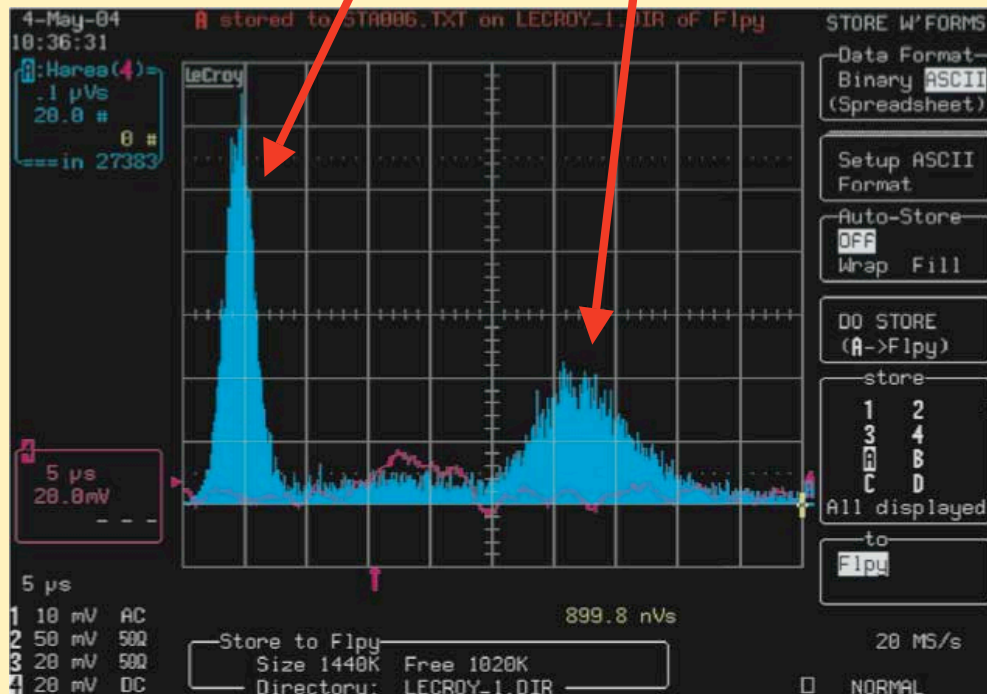



# High gain operation of LEM in pure Ar at high pressure

•Fe-55 & Cd-109 sources, Argon 100%, Room temperature

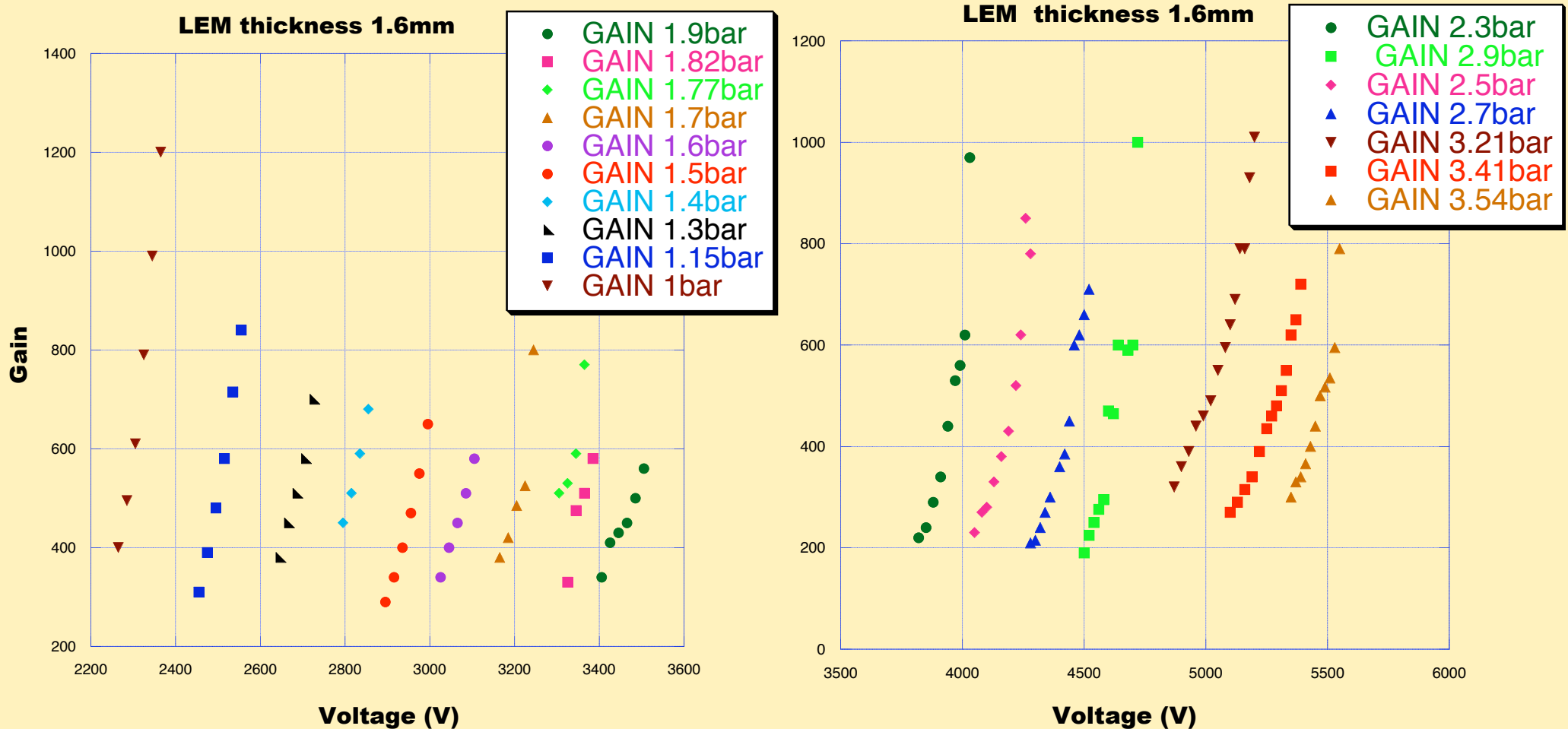

Gain up to  $\approx 800$  possible even at high pressure (good prospects for operation in cold)

Resolution  $\approx 28\%$  FWHM for Fe-55 source

Good agreement with GARFIELD simulations (confirm shower confinement)

# Drift very high voltage: Greinacher circuit

- ◆ No load to avoid resistive ripple
- ◆ Low frequency (50-500 Hz) to induce noise with a spectrum far from the bandwidth of the preamplifiers used to read out the wires or strips
- ◆ Possibility to stop feeding circuit during an event trigger

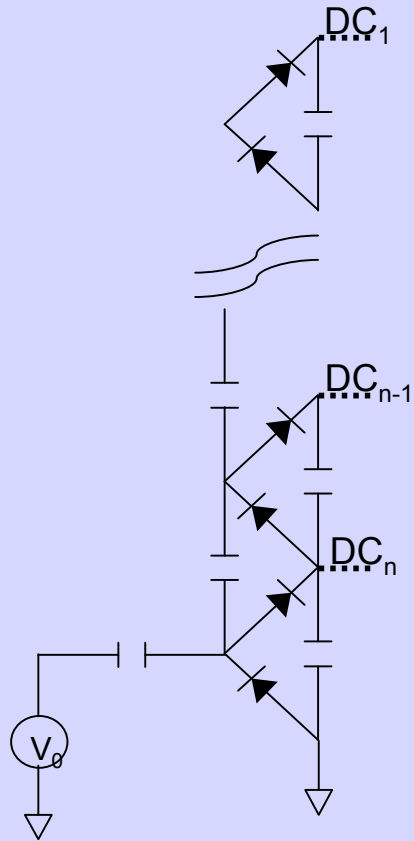

Greinacher or  
Cockcroft/Walton voltage  
multiplier

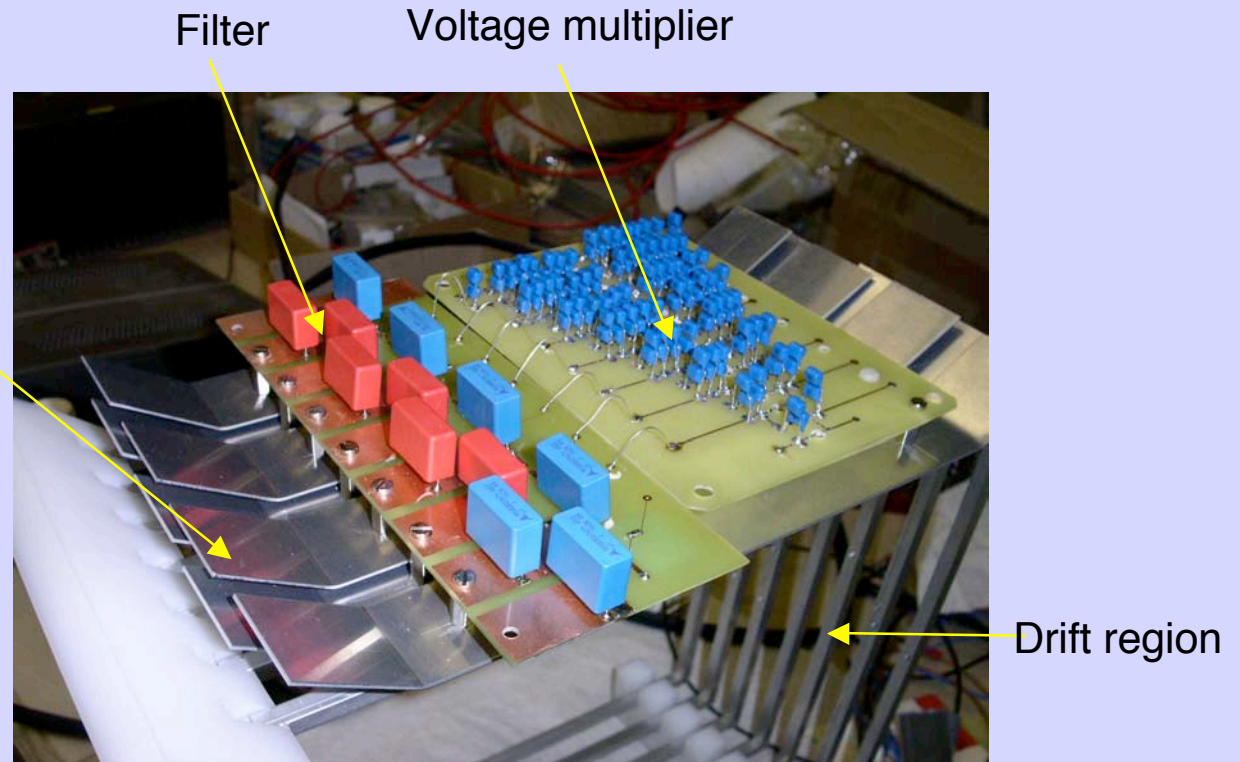

Prototype connected to actual electrodes  
of 50 liter TPC (ripple noise test)  
Successfully tested up to  $\approx 20\text{kV}$

## *Drift very high voltage: 40 kV multiplier in LAr*

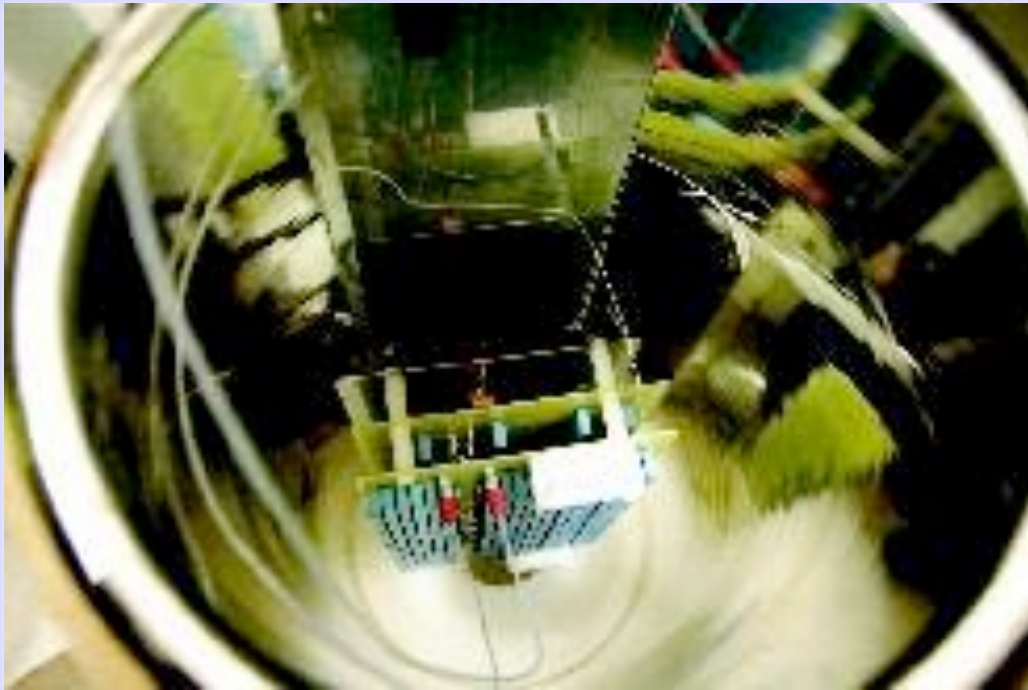

- NOVACAP(USA) NP0 dielectric capacitors, stable in temperature and against discharge. Tested successfully in our lab
- HV diodes from Vishay/Phillips

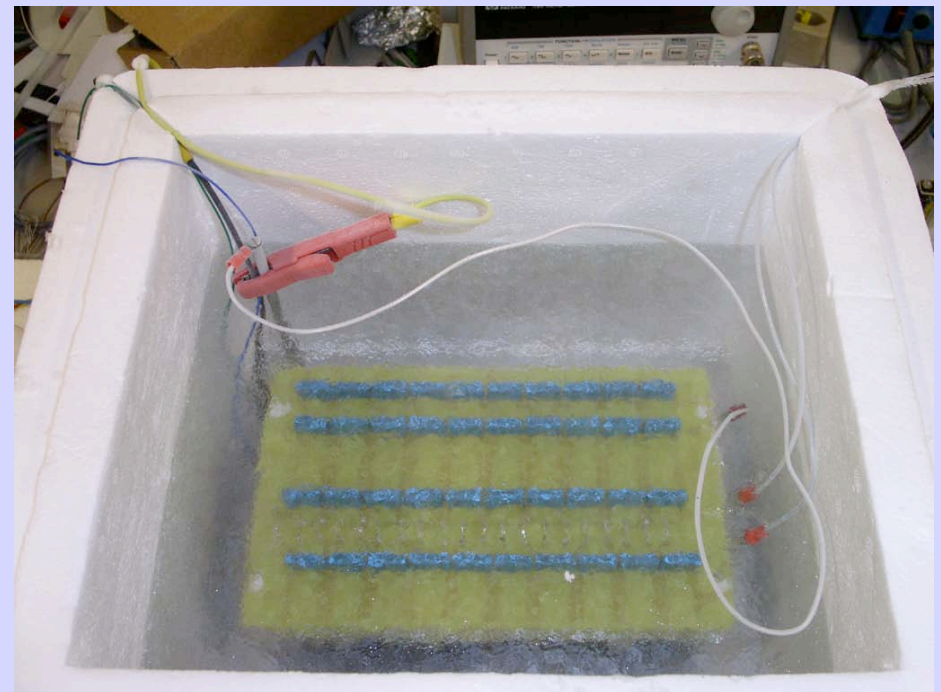
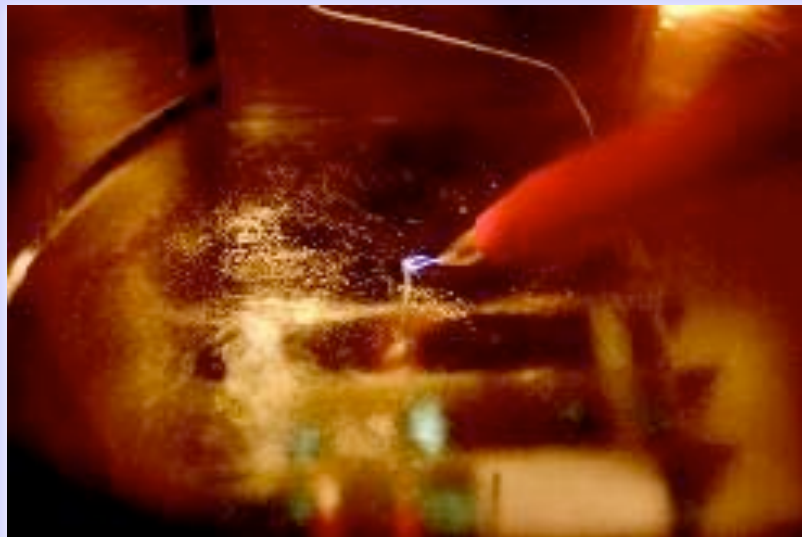

## ***Results from HV tests in cold***

- A large number of tests in cold have been performed in order to assess component choice and stability.
- The largest system successfully operated consisted of 80 stages and reached stable operation up to 120 kV.
- Test to 240 kV ( $\approx 4\text{kV/cm}$ ) in preparation.

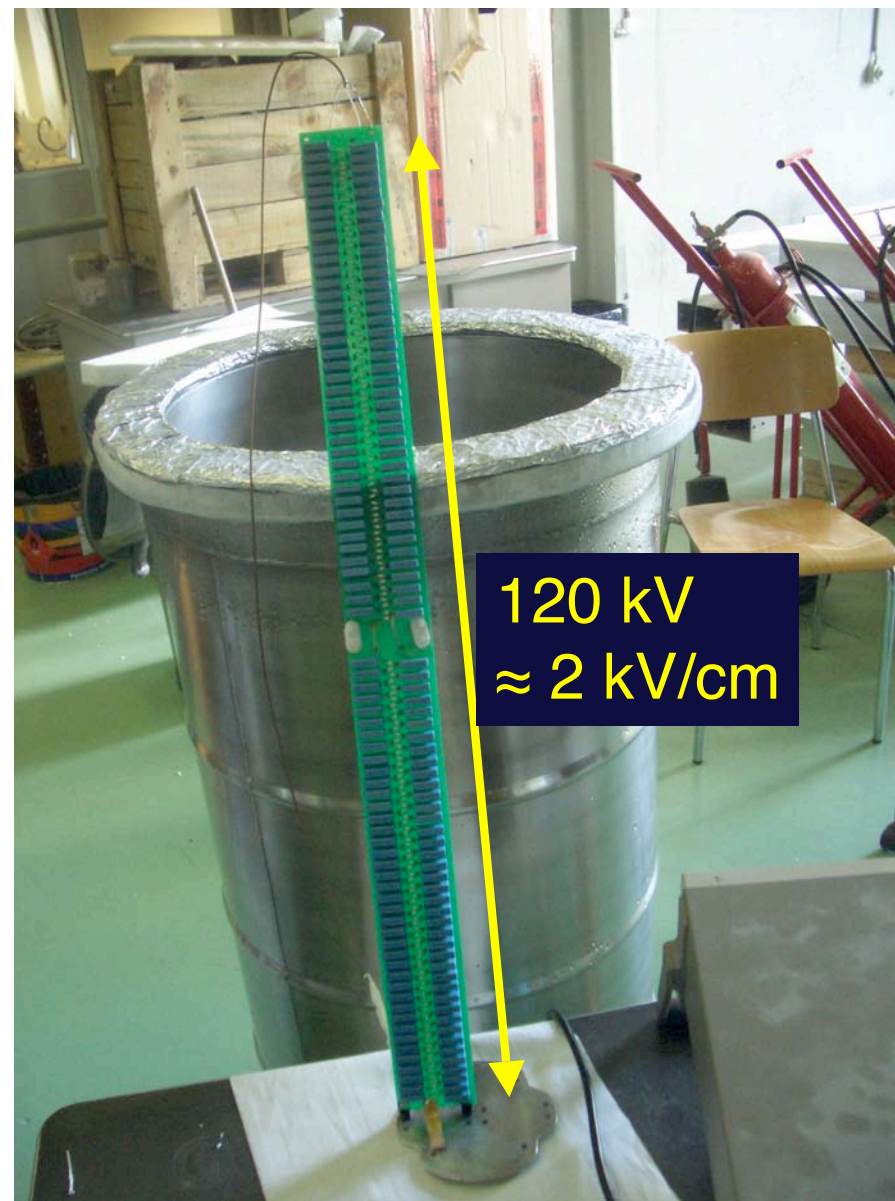
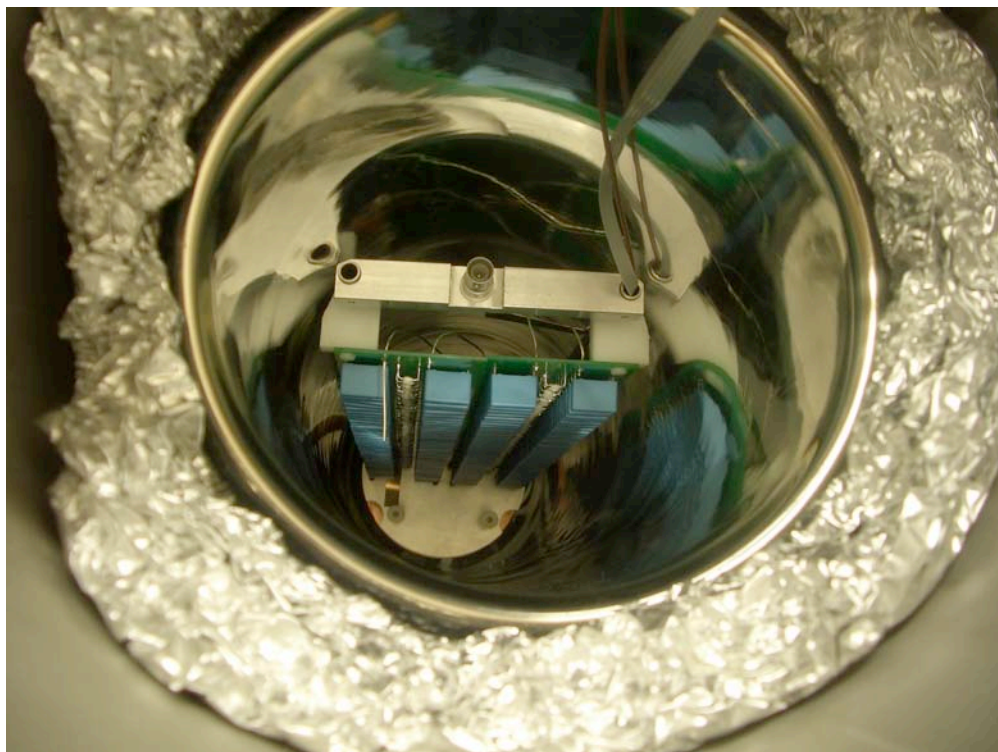

# High-pressure drift properties in liquid Argon

- **At the bottom of the large tankers:**  
Hydrostatic pressure could be quite significant (up to 3-4 atmosphere)
- **Test of electron drift properties in high pressure liquid Argon**  
Important to understand the electron drift properties and imaging under pressure above equilibrium vapor pressure

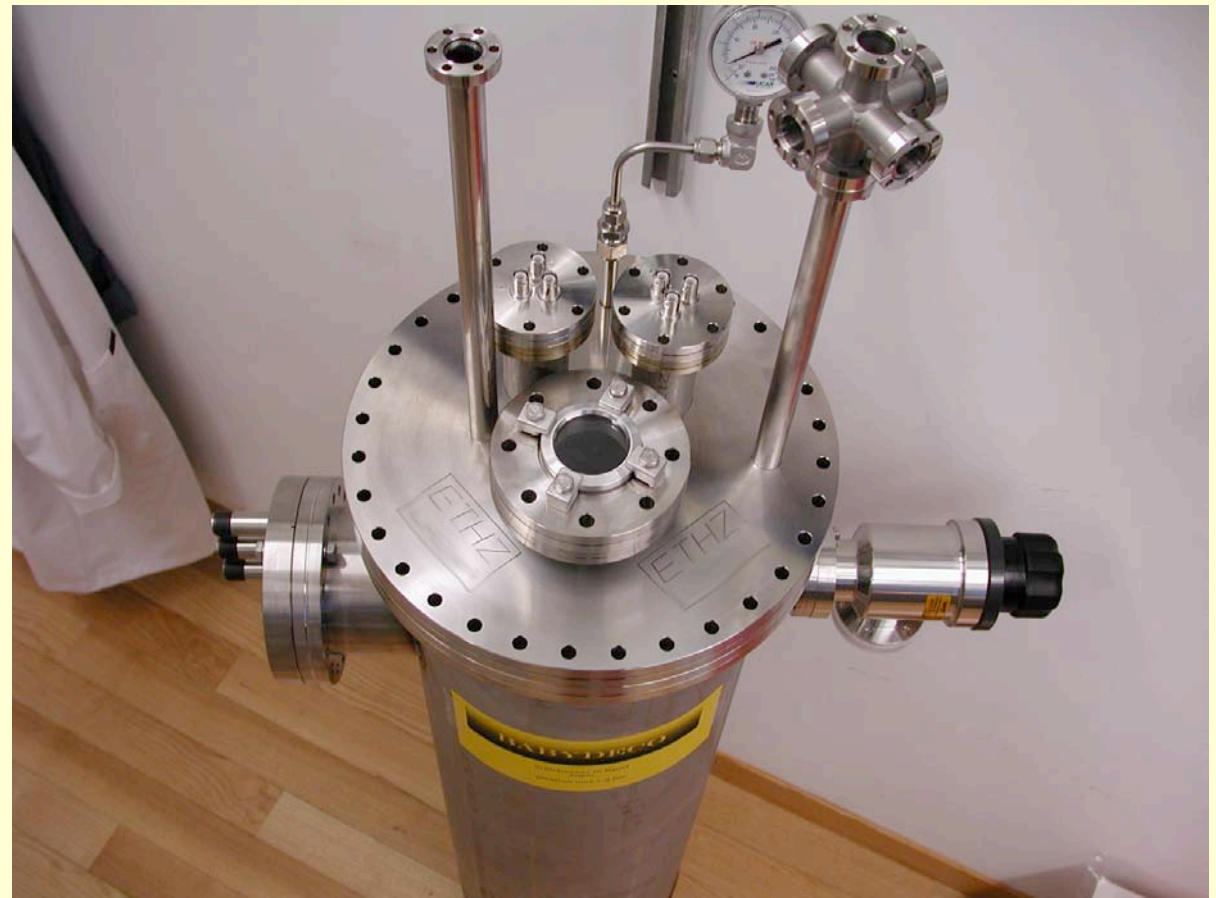
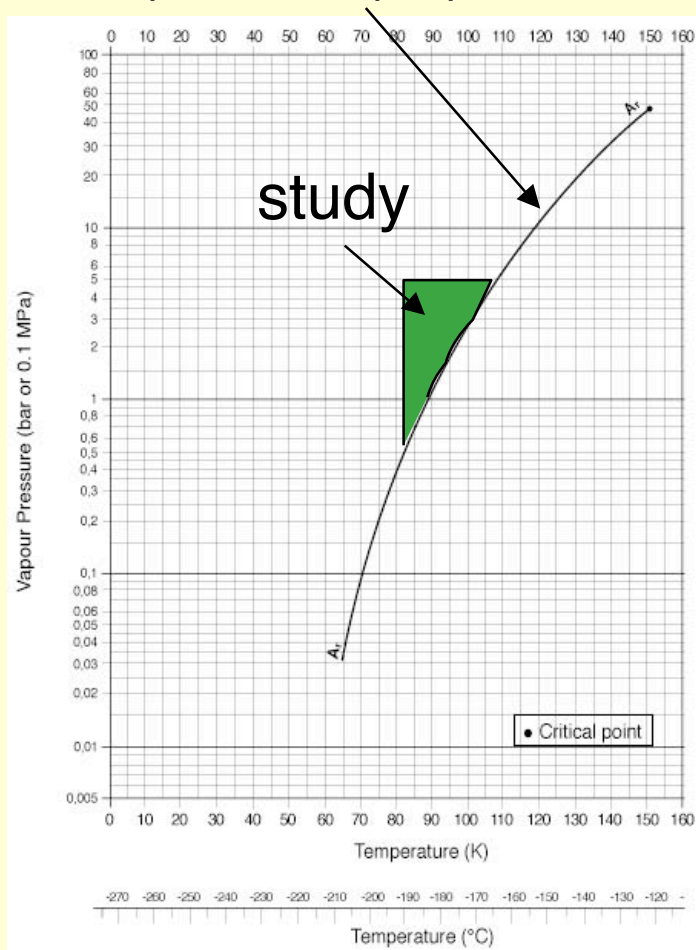

# Long drift, extraction, amplification: "ARGONTUBE"

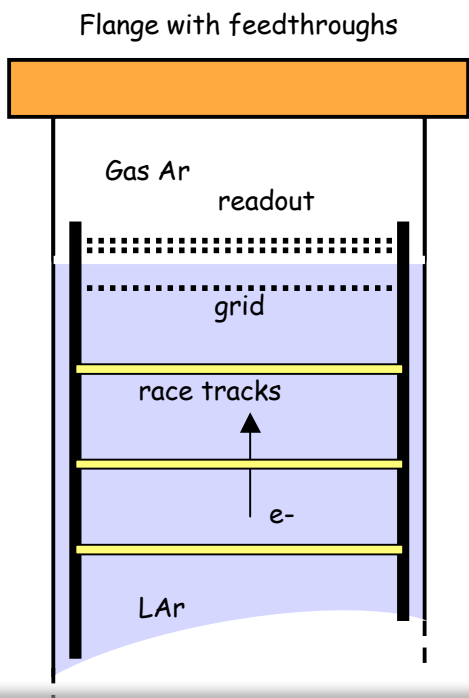

Extraction from LAr to Gas Ar and LEM readout

Field shaping electrodes

8" PMT  
ET 9357FLA

5 meters

Results in 2006

- Full scale measurement of long drift (5 m), signal attenuation and multiplication
- Simulate 'very long' drift (10-20 m) by reduced E field & LAr purity
- High voltage test (up to 500 kV)
- Design & assembly:  
completed: external dewar, detector container  
in progress: inner detector, readout system,  
...

Detector in the support structure  
(horizontal garage position)



Front view



*In Collaboration between INFN Napoli & ETHZ*

## Light collection for horizontal crossing muons

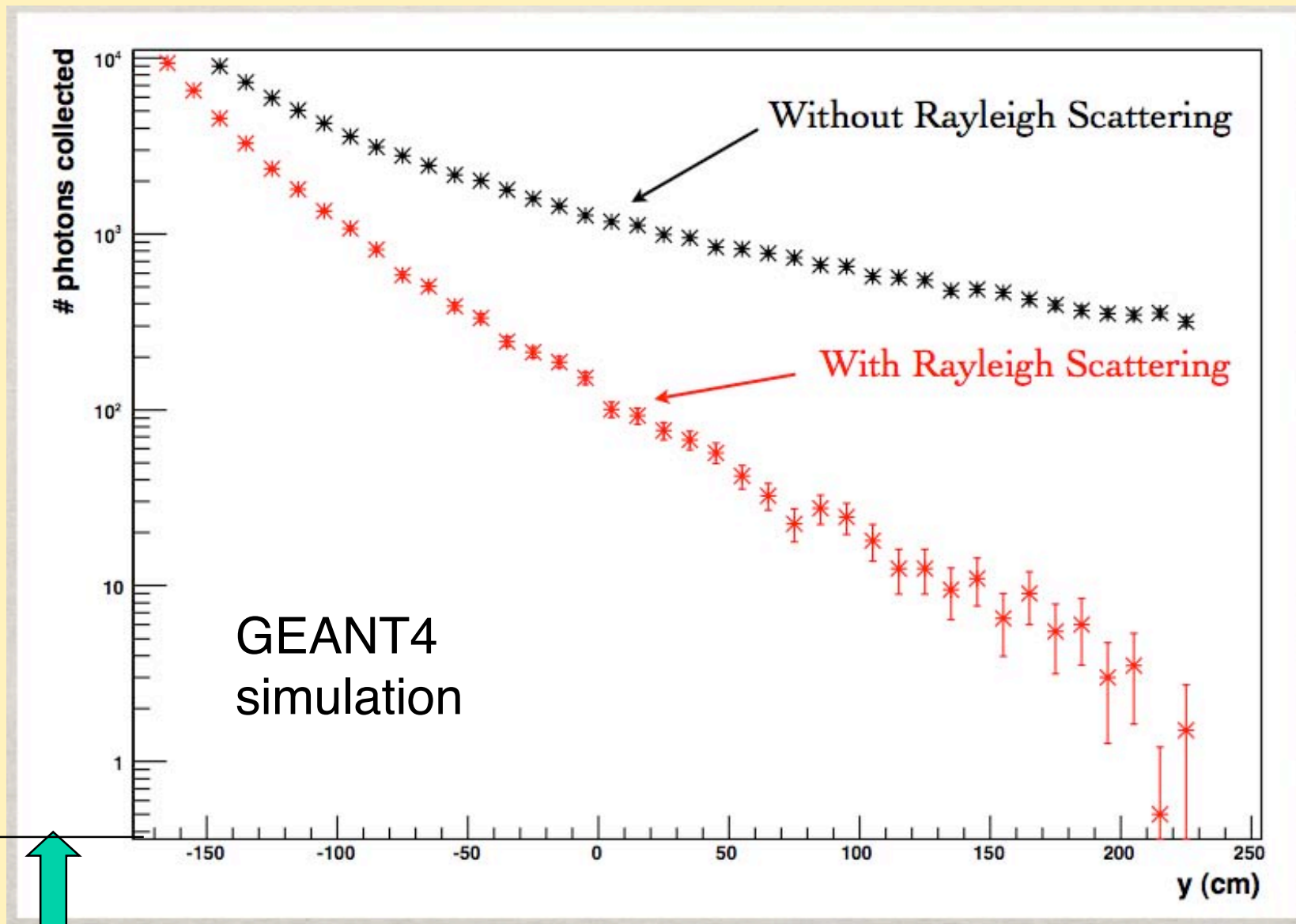



Shallow depth

## ***Example for 50m vs 188m rock overburden***

2D view 50 m underground

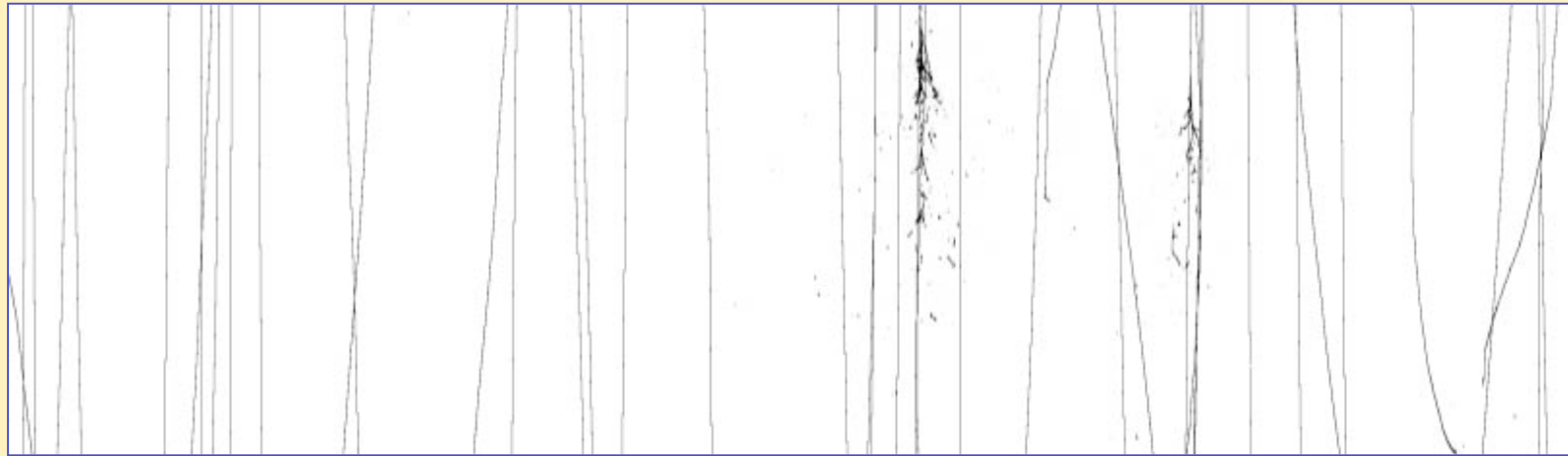

2D view 188 m underground

2500 samples = 2.5 m

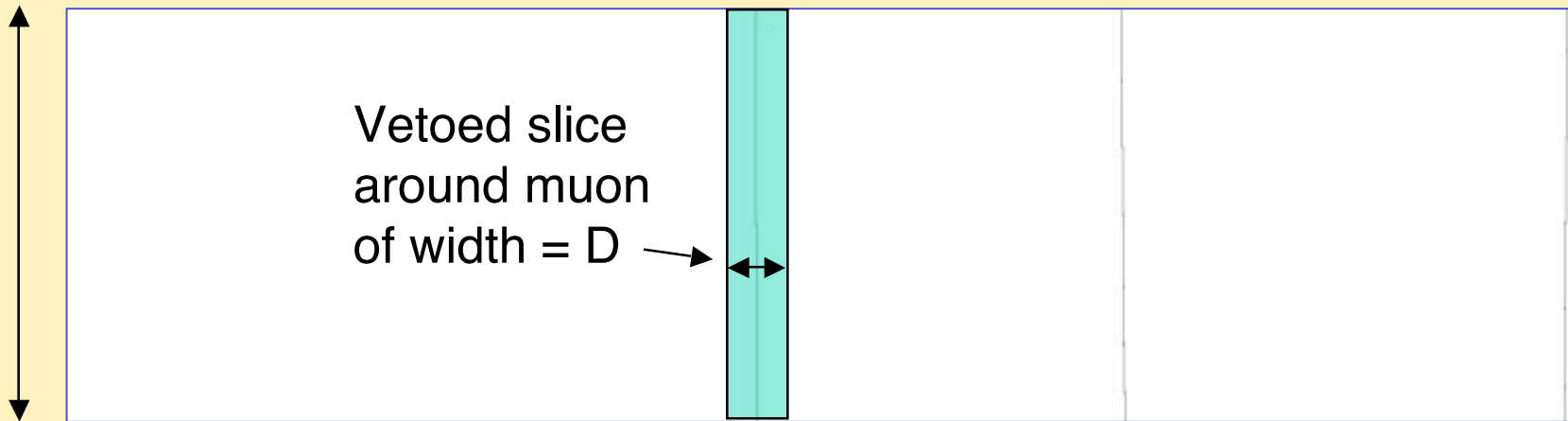

2700 channels = 8.1 m

## *Crossing muon rates at different detector depths*

*Muon flux on surface =  $70 \text{ m}^{-2} \text{ s}^{-1} \text{ sr}^{-1}$  with  $E_\mu > 1 \text{ GeV}$*

Depth rock	Total crossing muons ( $E > 1 \text{ GeV}$ ) per 10ms	Fiducial mass after slice of size D around each muon is vetoed		
		D=10 cm	D=20 cm	D=30 cm
Surface	<b>13000</b>	...	...	...
50 m	<b>100</b>	50 kton	25 kton	10 kton
<b>188 m</b>	<b>3.2</b>	98 kton	96 kton	94 kton
377 m (1 km w.e)	<b>0.65</b>	100 kton	100 kton	100 kton
755 m (2 km w.e)	<b>0.062</b>	100 kton	100 kton	100 kton
1.13 km (3 km w.e)	<b>0.010</b>	100 kton	100 kton	100 kton

Magnetic field

# *A superconducting magnetized LAr TPC detector*

- The presence of magnetic field is required for the application in the context of the NF. We can consider two fields:  $B=0.1$  T for the measurement of the muon charge (CP-violation), and  $B=1$  T for the measurement of the muon/electron charges (T-violation).
- We have demonstrated the possibility to use a LAr TPC in magnetic field (see *New J.Phys.*7:63 (2005) and *NIMA* 555 (2005) 294). This encouraging result now allows use to further consider a design with magnetic field.
- Hence, we propose to magnetize the very large LAr volume **by immersing a superconducting solenoid directly into the LAr tank to create a magnetic field, parallel to the drift-field.**
- For a  $B=0.1$ T (resp. 1T) the stored energy in the B-field is 280 MJ (resp. 30 GJ). In case of quenching of the coil, the LAr would absorb the dissipated heat which would produce a boil-off of 2 tons (resp. 200 tons) of LAr. This corresponds to 0.001% (resp. 0.1%) of the total LAr contained in the tank and hence favours once again our approach.
- In the superconducting phase, there is no heat dissipation and the current in the coil flows forever even when disconnected from the power supply.

# A possible improvement of the LAr TPC technique ?

## Operation of the LAr TPC embedded in a magnetic field

Nucl. Phys. B 631 239;  
Nucl. Phys. B 589 577;  
hep-ph/0402110;  
hep-ph/0106088

The possibility to complement the features of the LAr TPC with those provided by a magnetic field has been considered and would open new possibilities (a) **charge discrimination**, (b) **momentum measurement of particles escaping the detector** (e.g. high energy muons), (c) **very precise kinematics**, since the measurement precision is limited by multiple scattering. These features are mandatory at a NF.

Momentum measurement:

$$\frac{\Delta p}{p} \approx \frac{0.14}{B(\text{Tesla}) \sqrt{x(m)} \cos \lambda}$$

$x$ =track length

$\lambda$ =pitch angle

Required field for  $3\sigma$  charge discrimination:

$$B \geq \frac{0.2(\text{Tesla})}{\sqrt{x(m)} \cos^3 \lambda}$$

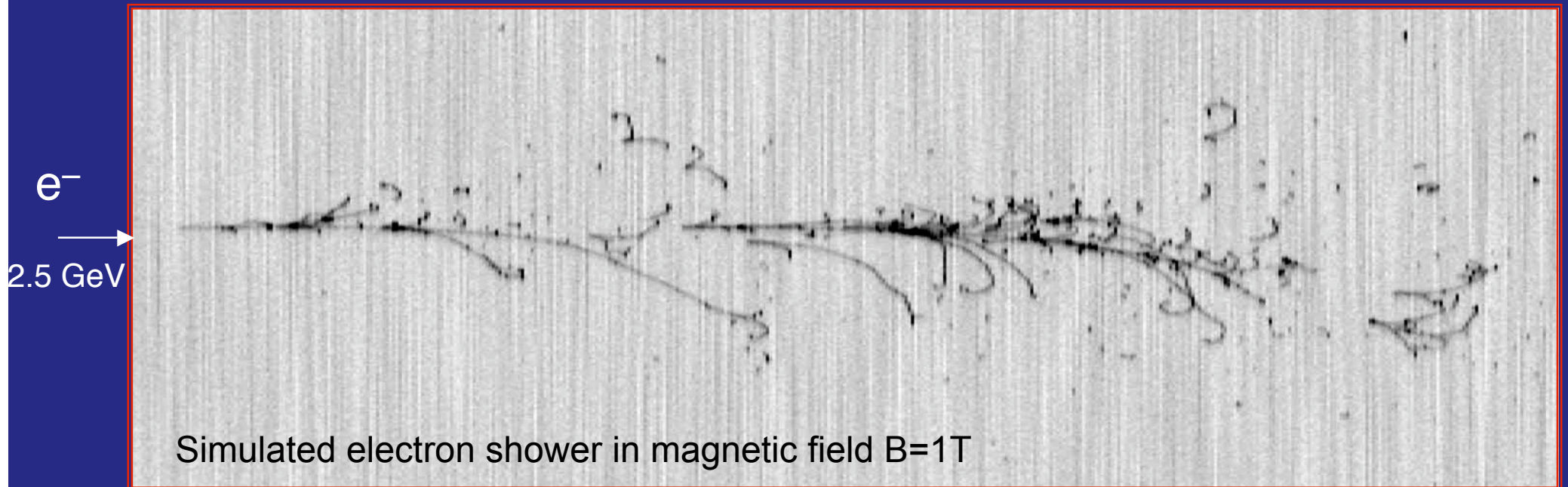

# First operation of a 10 t LAr TPC embedded in a B-field

First real events in B-field ( $B=0.55\text{T}$ ):

New J. Phys. 7 (2005) 63

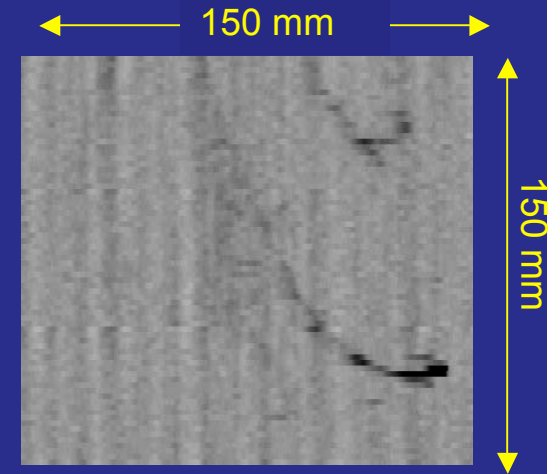
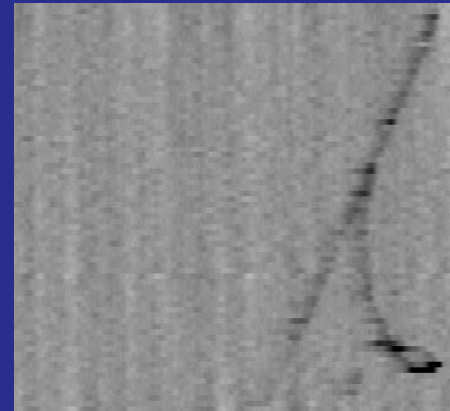
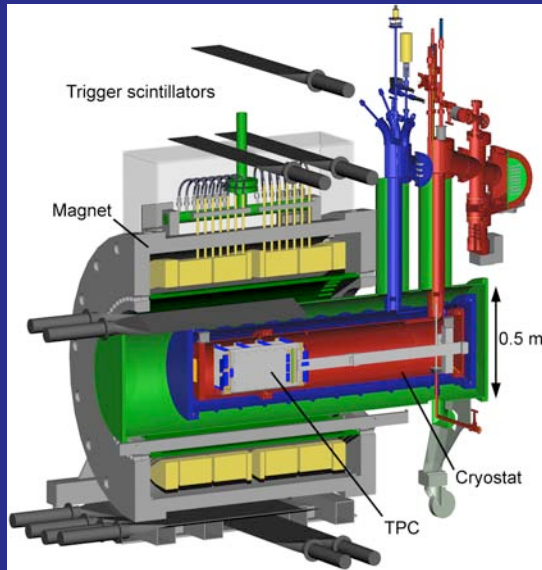

Correlation between calorimetry and magnetic measurement for contained tracks:

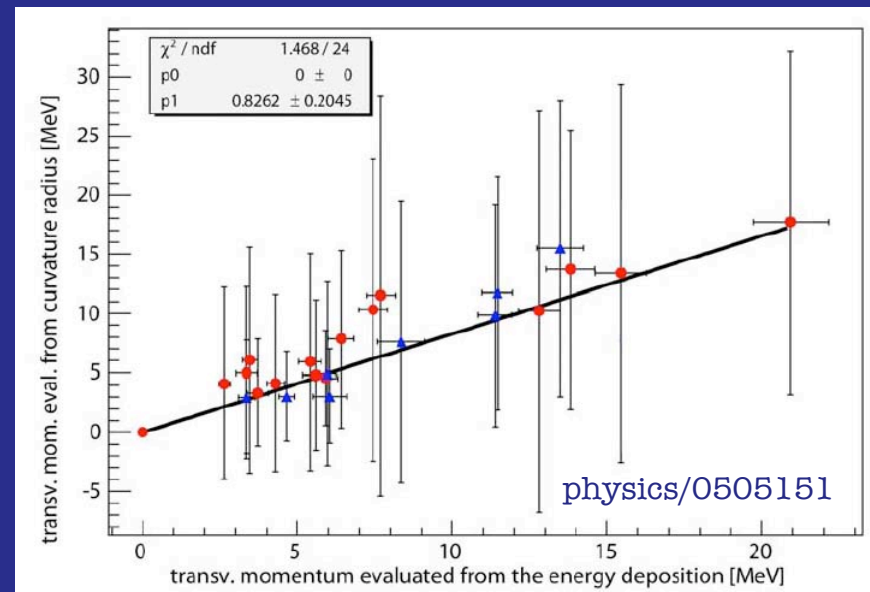
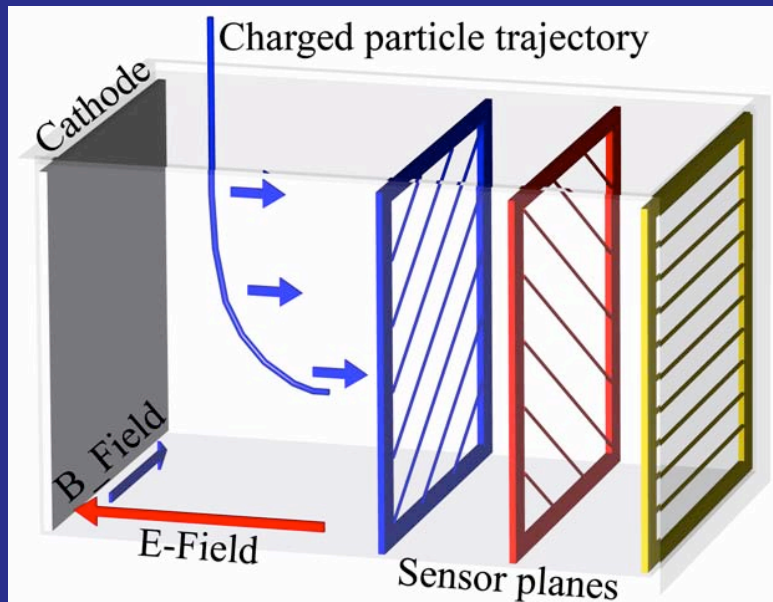

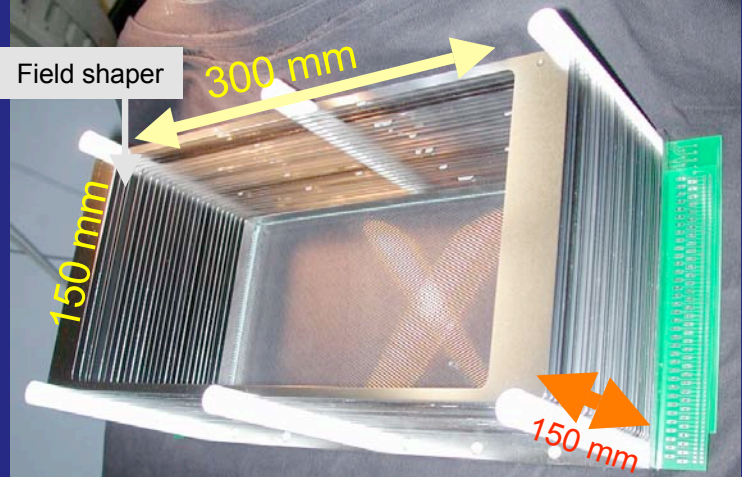
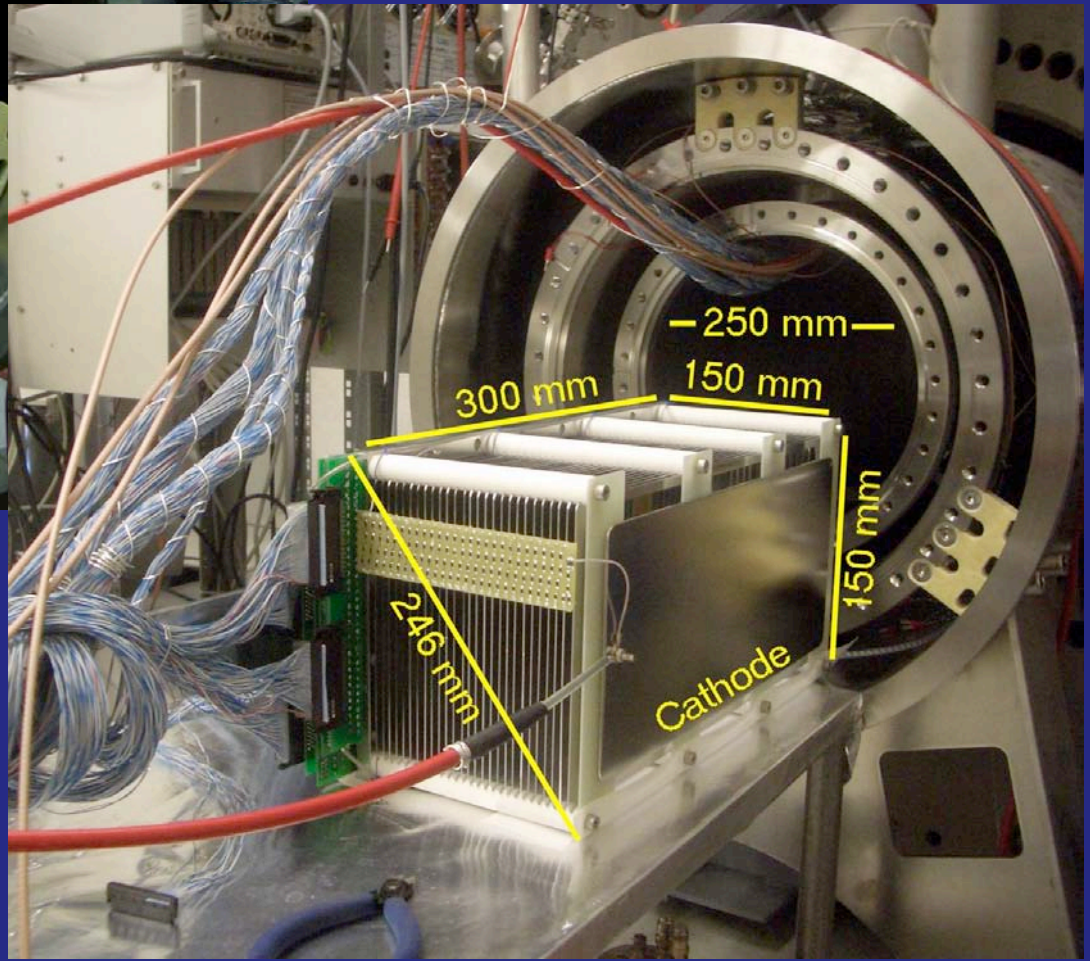
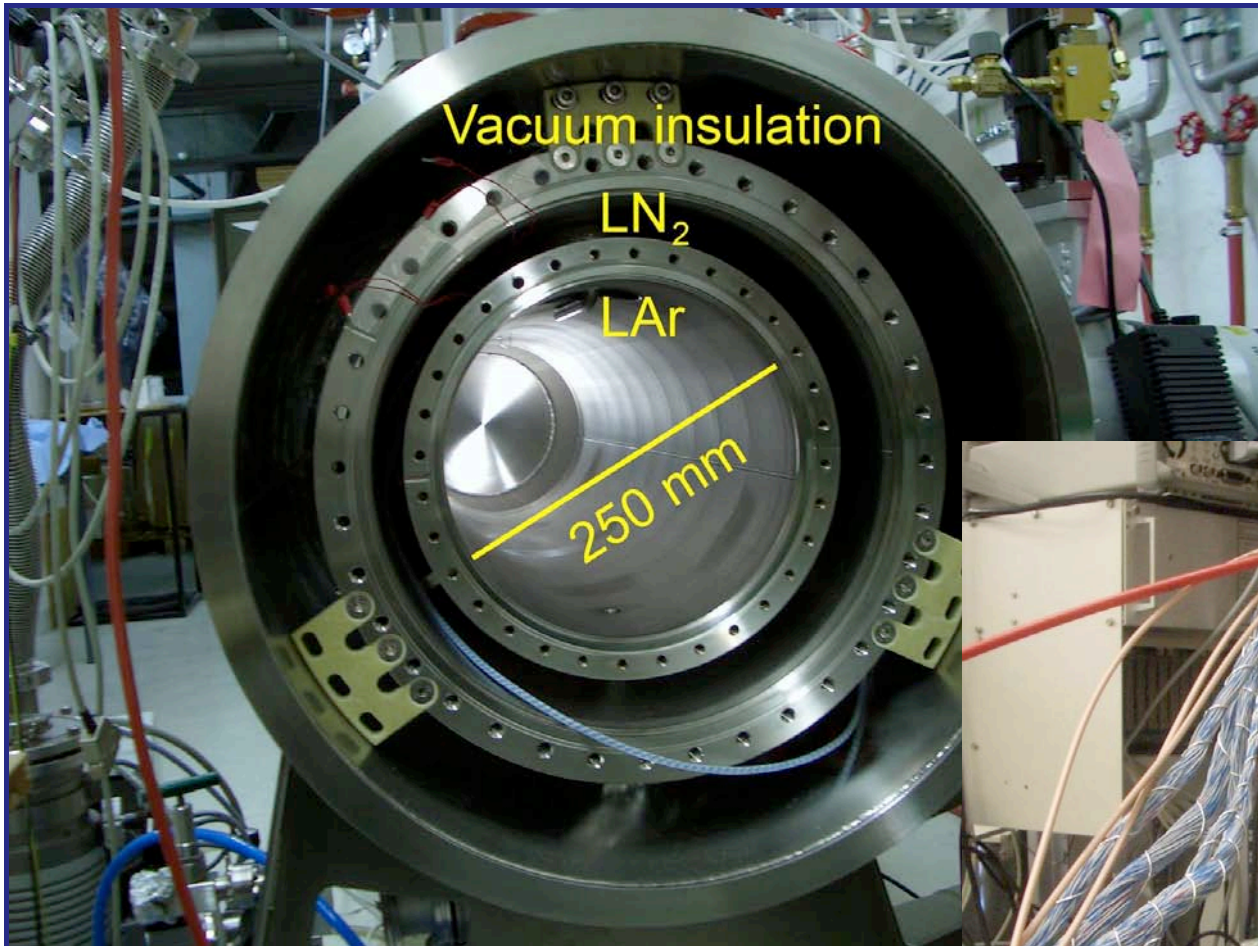



# Tentative layout of a large magnetized GLACIER

Magnet: solenoidal superconducting coil

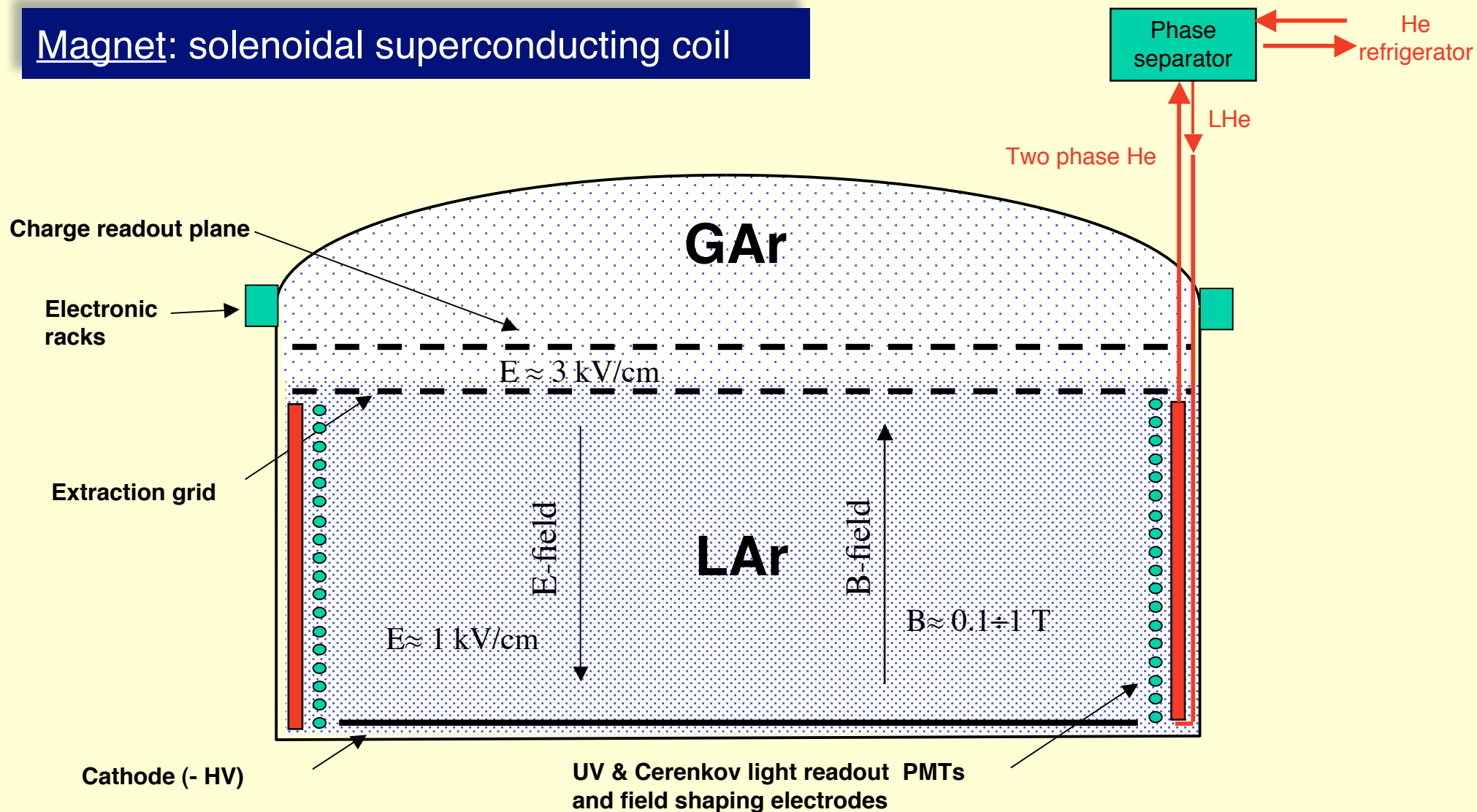

LHe Cooling: Thermosiphon principle + thermal shield=LAr

## *Tentative coil parameters*

*Other examples: ALEPH, CDF, ATLAS Toroids, AMS-II*

	10 kton LAr			100 kton LAr			ATLAS solenoid	CMS
Magnetic induction (T)	0.1	0.4	1.0	0.1	0.4	1.0	2.0	4.0
Solenoid diameter (m)	30			70			2.4	6
Solenoid length (m)	10			20			5.3	12.5
Magnetic volume (m <sup>3</sup> )	7700			77000			21	400
Stored magnetic energy (GJ)	0.03	0.5	3	0.3	5	30	0.04	2.7
Magnetomotive force (MA <sub>t</sub> )	0.8	3.2	8	1.6	6.4	16	9.3	42
Radial magnetic pressure (kPa)	4	64	400	4	64	400	1600	6500
Coil current (kA)	30 ( $I/I_c=50\%$ )						8	20
Total length conductor (km)	2.5	10	25	12	57	117	5.6	45
Conductor type	NbTi/Cu normal superconductor, T=4.4K							

(Detailed magnetic, mechanical, thermal and quench analysis yet to be performed...)

## **Other challenge: High $T_c$ superconductors ?**

- A new era in superconductivity opened in 1986 when Bednorz and Mueller in Zürich discovered superconductivity at a temperature of approximately 30K. In the following years, new materials were found and currently the world record is  $T_c \approx 130\text{K}$ .
- HTS are fragile materials and are still at the forefront of material science research. For example, BSCCO-2212 ( $\text{Bi}_2\text{-Sr}_2\text{-Ca}_2\text{-Cu}_3\text{-O}_{10}$ ) with  $T_c = 110\text{ K}$  is promising. Tapes of Bi2223 or YBCO coated are promising HTS cables.
- Magnets have been constructed although HTS do not tolerate high magnetic fields.
- **Massive R&D required ! See Superconducting Magnetic Energy Storage (SMES)**

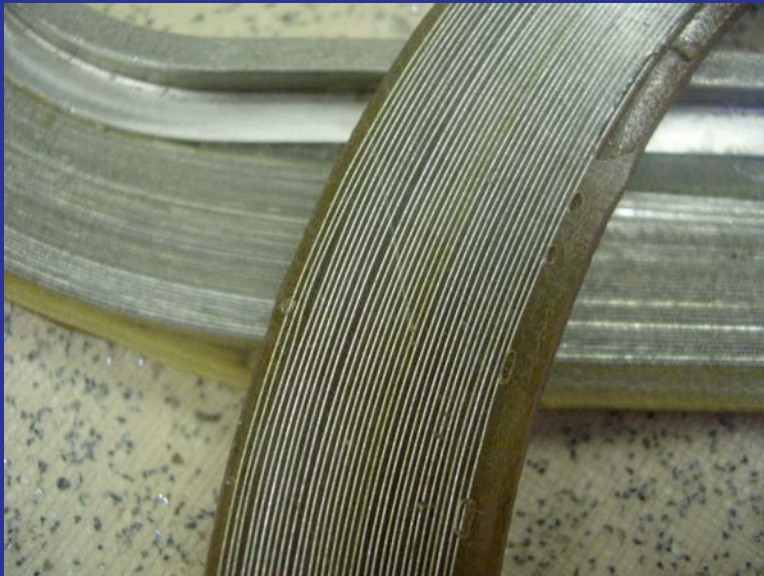

*Example of BSCCO-2212 coils (Cryo department, Southampton Univ, UK)*

## Tentative Yoke parameters

Cylindrical Fe yoke	10 kton LAr			100 kton LAr		
Magnetic induction (T)	0.1	0.4	1.0	0.1	0.4	1.0
Magnetic flux (Weber)	70	280	710	385	1540	3850
Assumed saturation field in Fe (T)	1.8			1.8		
Thickness (m)	0.4	1.6	3.7	1	3.7	8.7
Height (m)	10			20		
Mass (kton)	6.3	25	63	34	137	342

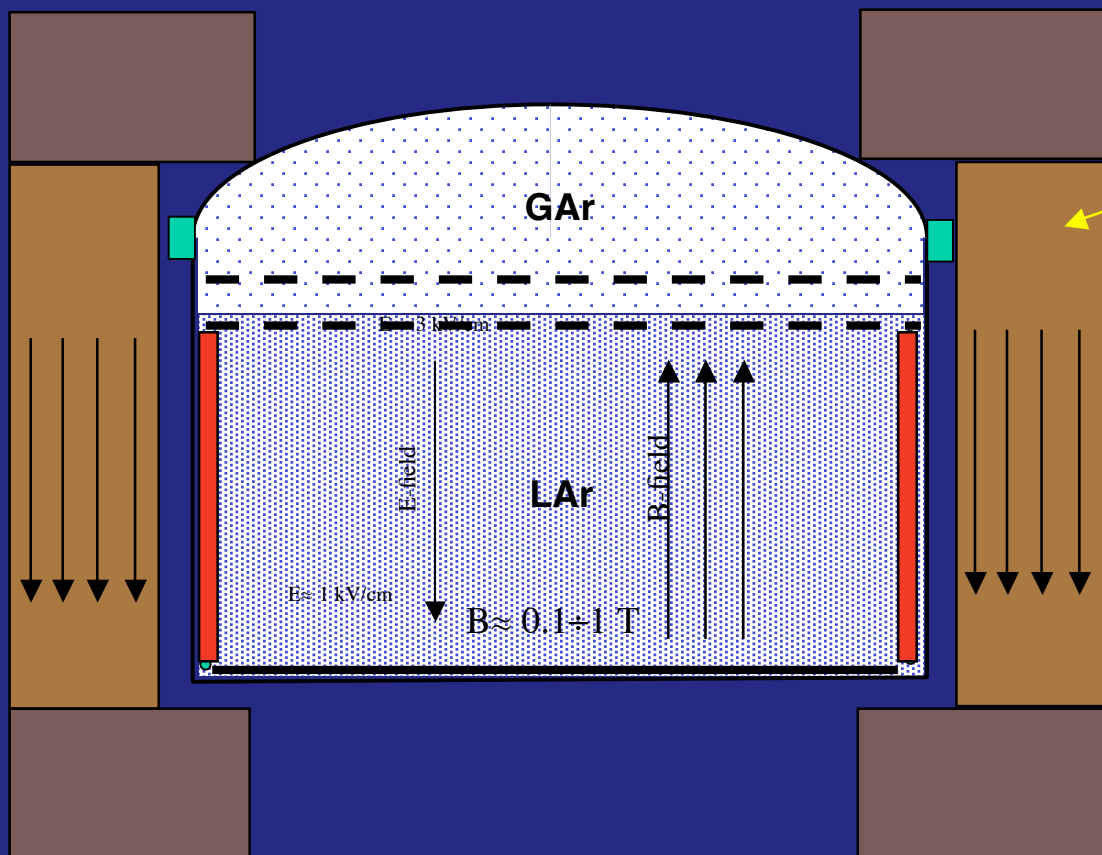

Cylindrical Fe yoke.  
(Instrumented?)

*NB: Superconducting Magnetic Energy Storage (SMES) systems were considered for underground storage of MJ energy without return yoke buried in tunnels in bedrock (see e.g. Eyssa and Hilal, J. Phys. D: Appl. Phys 13 (1980) 69). Avoid using a yoke?*

# Example of the CMS Superconducting Magnet:

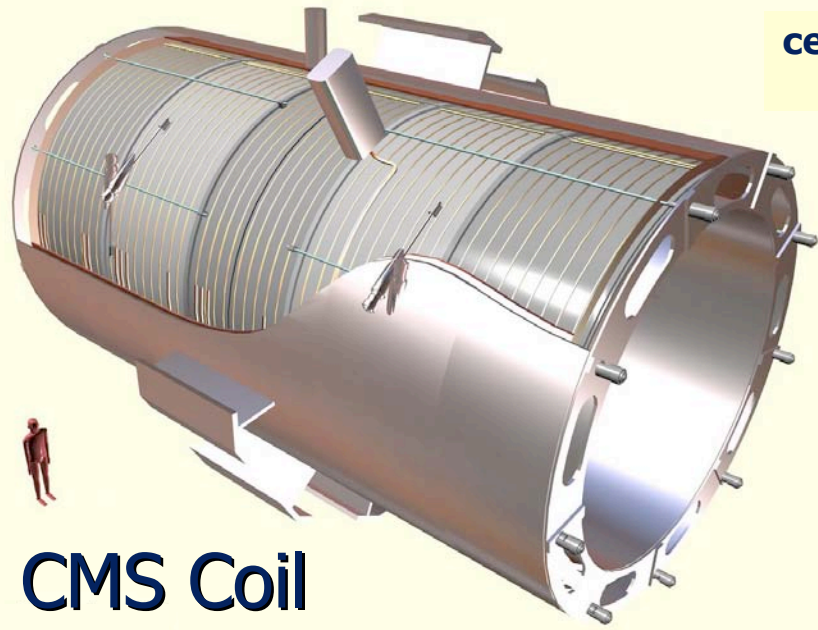

CMS Coil

central magnetic field:  
**4 T**

nominal current:  
**20'000 A**

stored energy:  
**2.7 GJ**

length:  
**12.5 m**

diameter:  
**6 m**

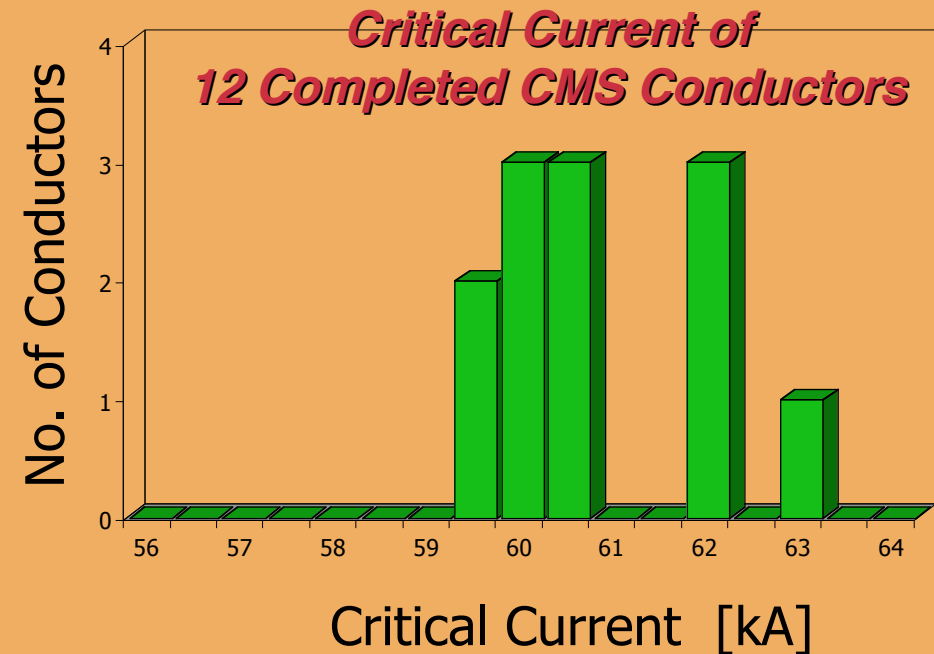
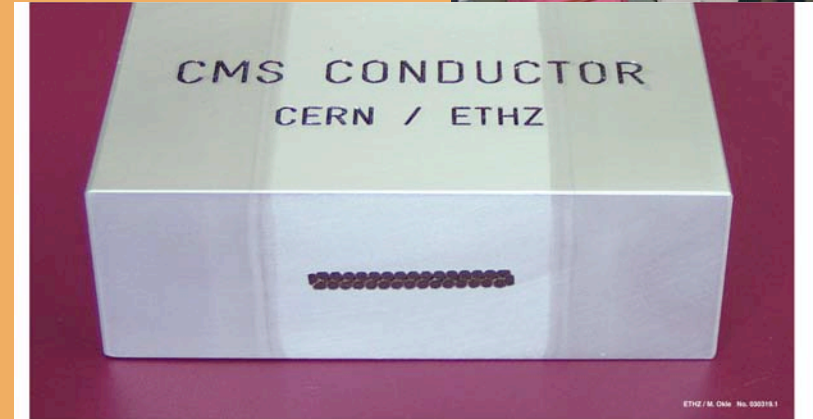

# First tests of HTS conductor in Liquid Argon

- We have performed first tests with BSCCO HTS superconductor by American Superconductor ([www.amsuper.com](http://www.amsuper.com)) in order to compare critical currents and influence of stray-field at LAr temperature (rather than LN<sub>2</sub>).

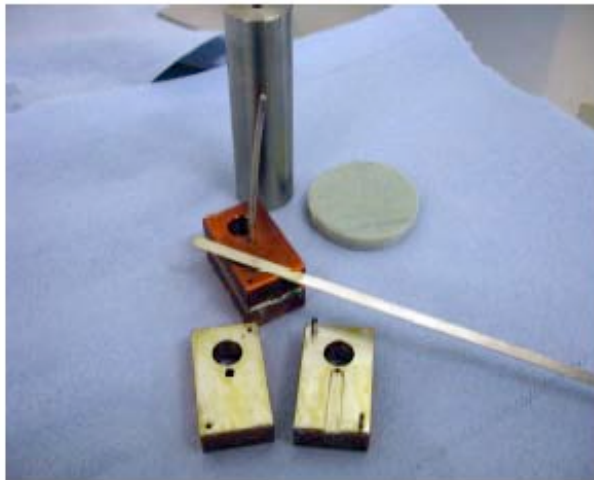
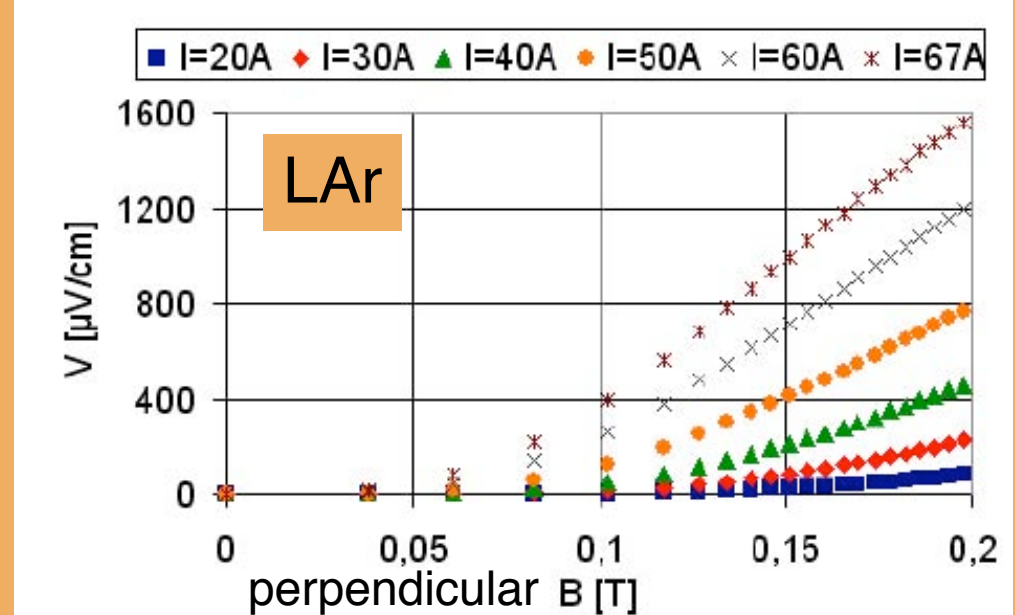
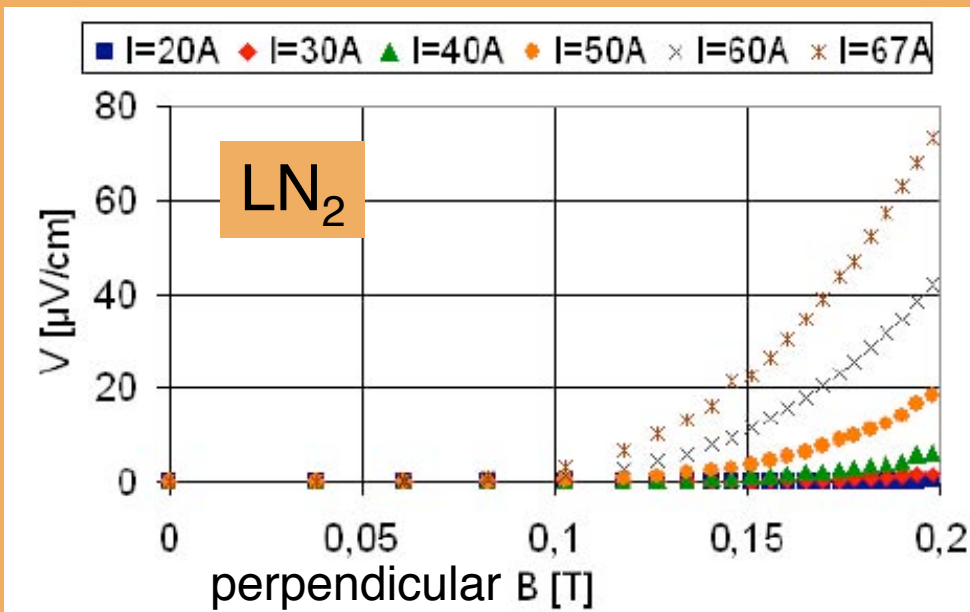

Diploma student  
T. Strauss

*This is very preliminary...*

## ***Building a small solenoid with HTS wire pancakes***

After encouraging results, we decided to build a small HTS magnet

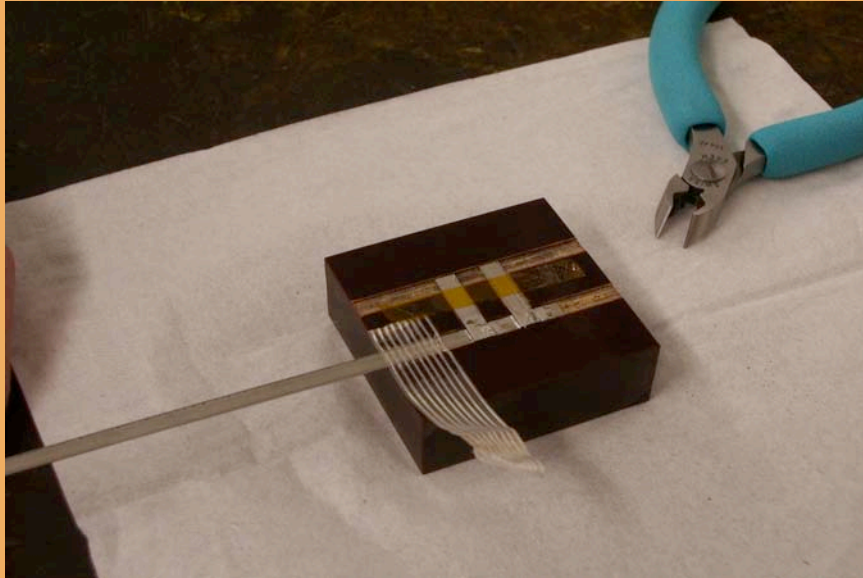

## ***“Home-made” HTS coil***

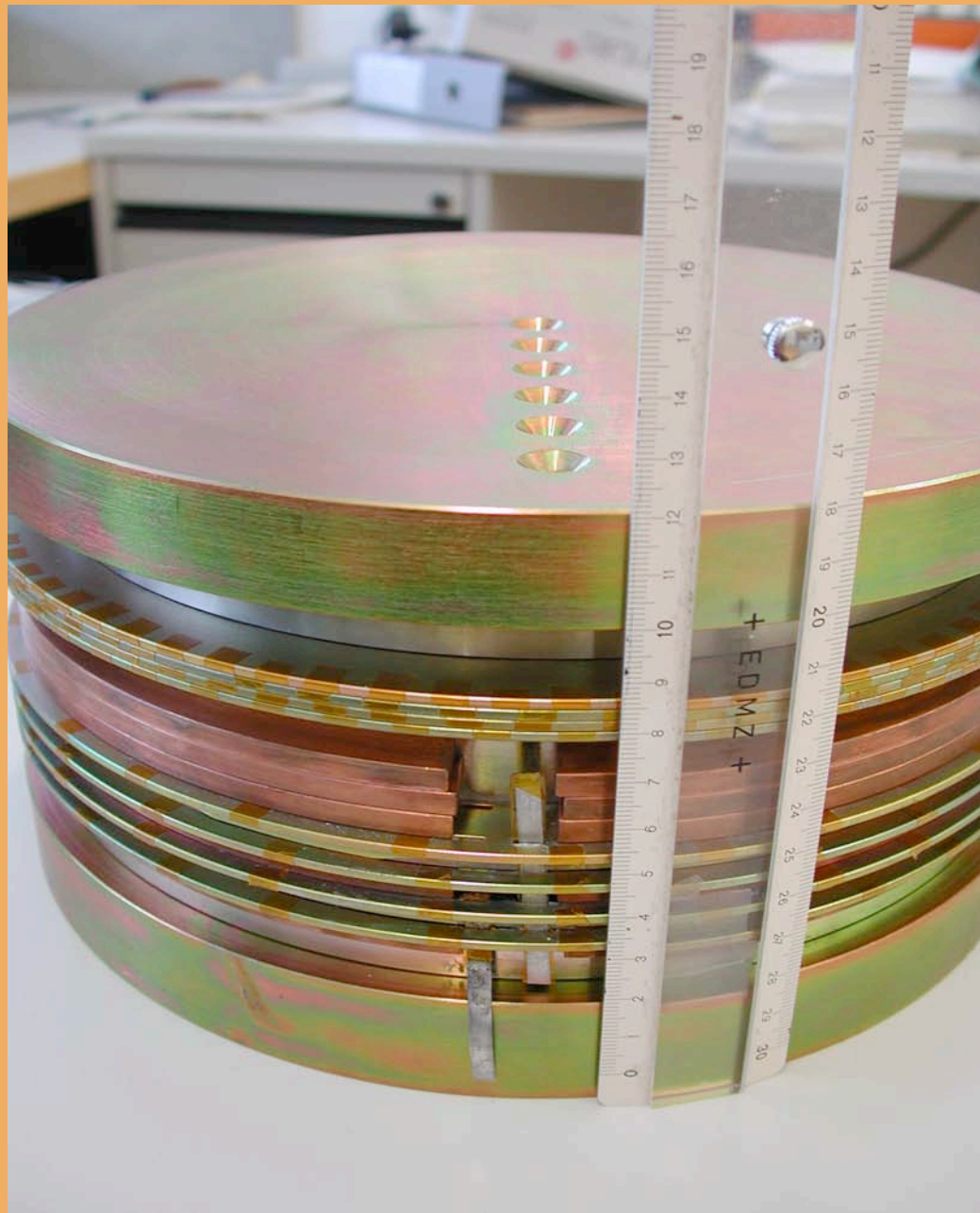



## Magnetic field of 2 pancakes (24 windings, diameter 12.5 cm, $I = 68$ A)

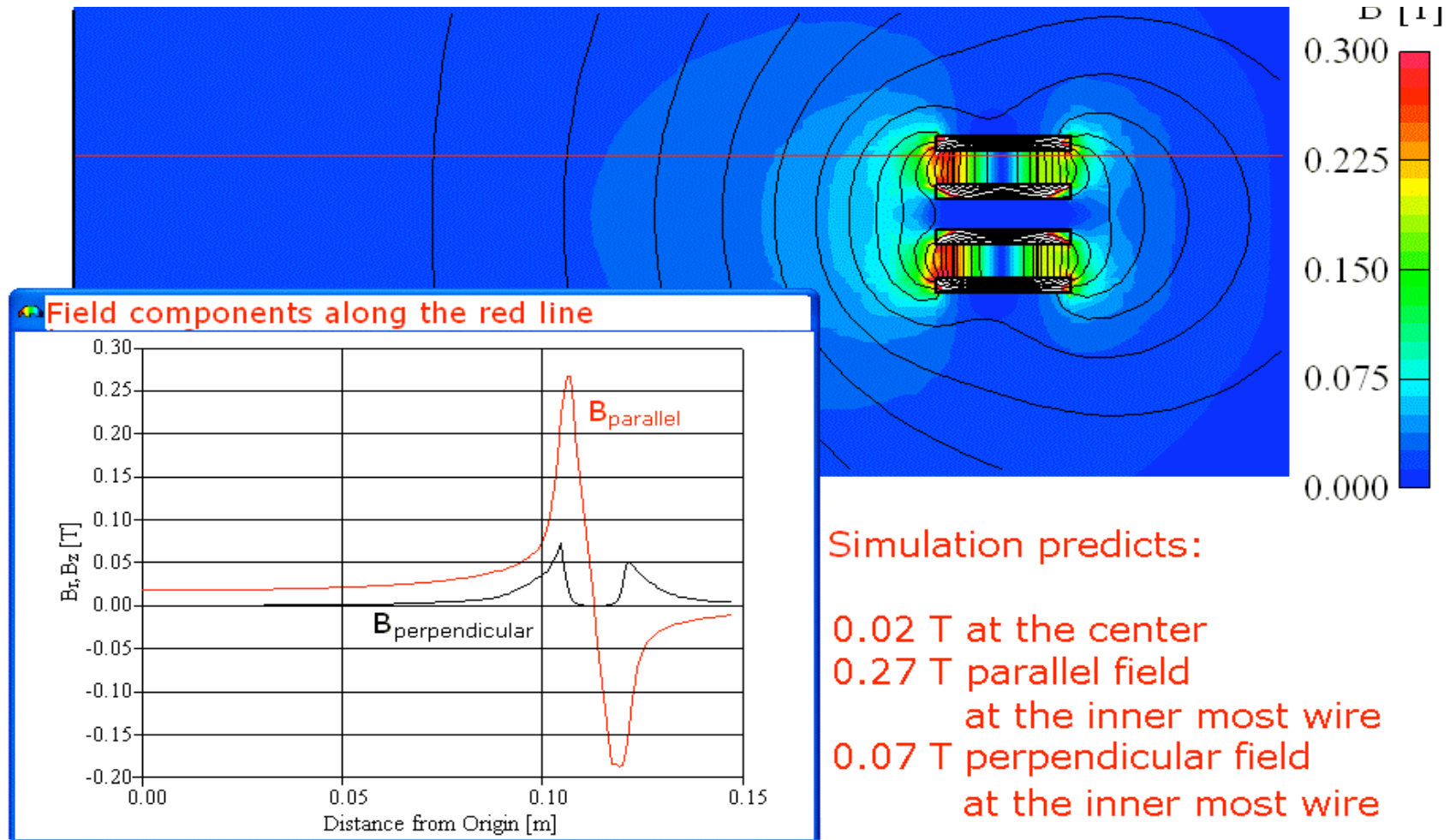

Simulation predicts:

- 0.02 T at the center
- 0.27 T parallel field  
at the inner most wire
- 0.07 T perpendicular field  
at the inner most wire

Measurements in  $\text{LN}_2$ :

- 0.02 T at the center of the magnet
- 0.1 T at the inner surface of the coil support  
(4 mm from inner most wire)

Setup resistance for  $I=4$  A:  $2 \mu\text{V}$   
for  $I=68$  A:  $3 \mu\text{V}$

An important milestone...

*Important milestone of the LAr TPC technique for accelerator neutrino physics*

*A 100 ton detector for the 2 km site of the T2K experiment*

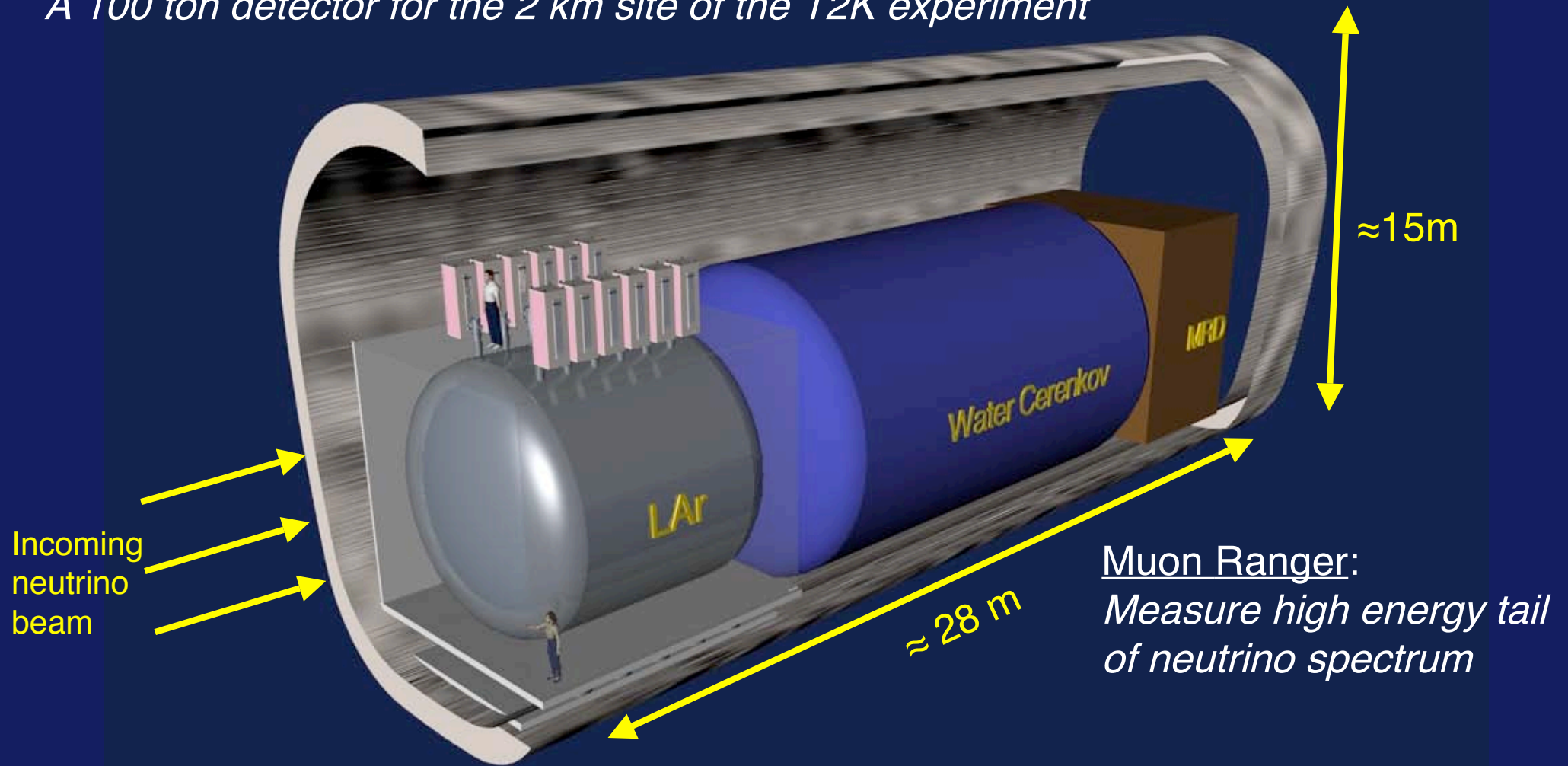

Incoming  
neutrino  
beam

≈15m

≈28 m

Muon Ranger:  
*Measure high energy tail  
of neutrino spectrum*

Liquid Argon detector:  
*Exclusive final states  
Frozen water target*

Water Cerenkov detector:  
*Same detector technology as SK  
≈1 interaction/spill/kton*

# Summary

- **R&D program needed to build O(100 kton) liquid Argon TPC under progress**
  - ↳ Internal issues: Purification, long drift paths, magnetic field,...
  - ↳ External issues: safety, modularity (installation, access, operation, ...)
- **The state of the art of our conceptual design has been presented.**
- **It relies on**
  - ↳ (a) industrial tankers developed by the petrochemical industry (no R&D required, readily available, safe) and their extrapolation to underground or shallow depth LAr storage
  - ↳ (b) novel readout method for very long drift paths w e.g. LEM readout
  - ↳ (c) new solutions for very high drift voltage
  - ↳ (d) a modularity at the level of 100 kton (limited by cavern size)
  - ↳ (e) the possibility to embed the LAr in B-field (conceptually proven).  
Magnetic field strength to be determined by physics requirements.

## Guideline for future large scale LAr technology development

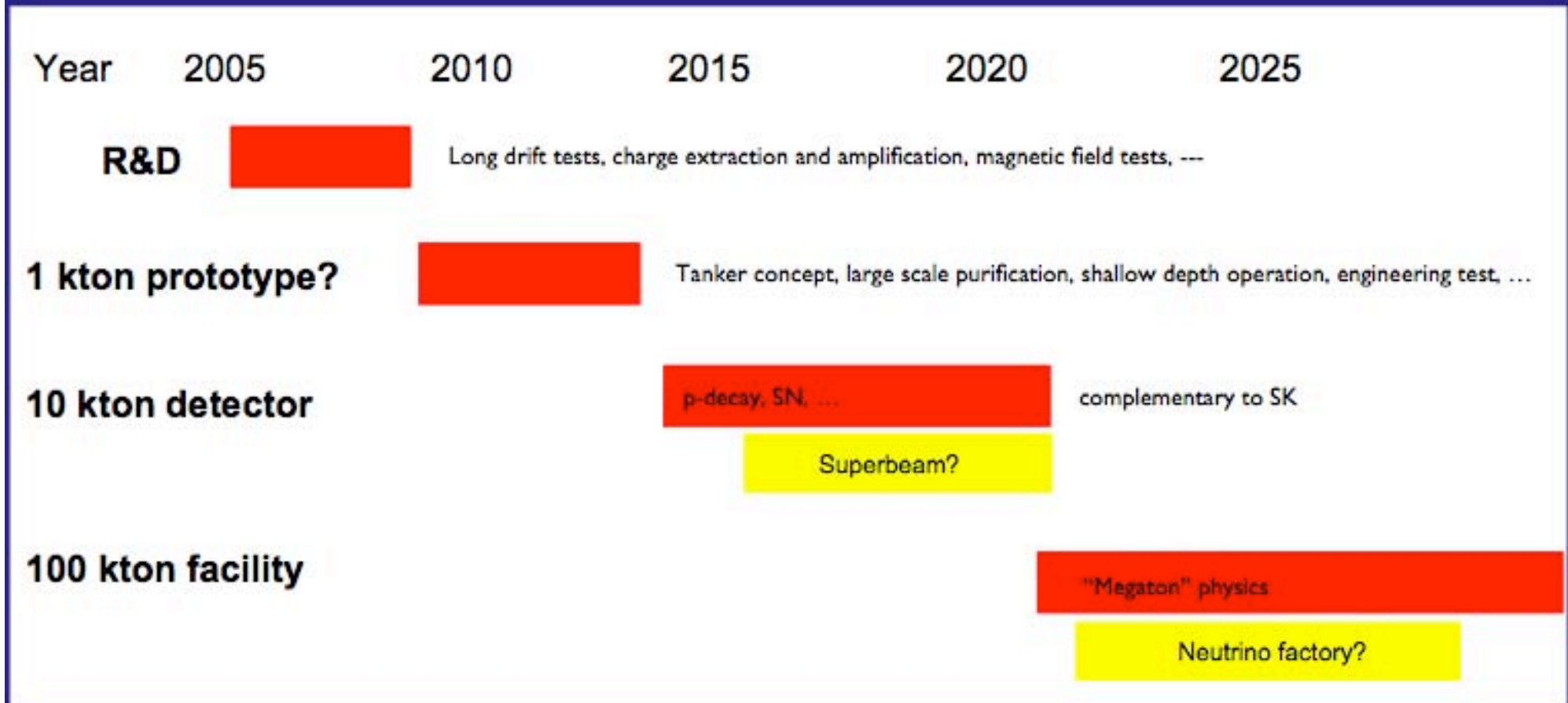

*The R&D plan is consistent with the tentative ApPEC roadmap*