



Towards a new Liquid Argon Imaging Chamber for the MODULAR project

F. Pietropaolo (ICARUS collaboration)

NNN '08 Workshop
Paris, 10-13 September 2008



Beyond ICARUS-T600

- The forthcoming operation of the ICARUS-T600 detector in the LNGS Hall-B will represent the completion of the development of the LAr-TPC imaging chamber lasted over more than two decades.
- The operation of the T600 will evidences the large number of important milestones which have been already achieved in the last several years, opening the way to the development of of new line of modular elements, which may be progressively extrapolated to the largest conceivable LAr-TPC sensitive masses.
- Based on the T600 experience, the ICARUS collaboration is now proposing a next generation LAr-TPC in tens of kt scale: **the MODULAr project**. The new detector will maintain the majority of components that have been developed with industry for the T600. This detector might be easily upgraded in the far future to a larger scale, depending on the potential physics goals.



The MODULAR programme

- The MODULAR project is considering an opportunity for the CERN/GranSasso (CNGS) neutrino complex, concurrent time-wise with T2K and NOvA projects, with the aim of improving the sensitivity on $\nu_{\mu} \leftrightarrow \nu_e$ θ_{13} mixing angle by nearly an order of magnitude with respect to T2K expectations.
- The experiment is based on a ≈ 20 kt fiducial volume LAr-TPC, following very closely the technology developed for the ICARUS-T600 detector.
- Compared with large water Cherenkov (T2K) and fine grained scintillators (NOvA), the LAr-TPC offers a higher detection efficiency for a given mass and lower backgrounds, since virtually all channels may be unambiguously recognized.
- In addition to the search for θ_{13} oscillations and CP violation, it would be possible to collect a large number of accurately identified cosmic ray neutrino events and perform search for proton decay in the exotic channels.

The ICARUS LAr-TPC: an electronic bubble chamber

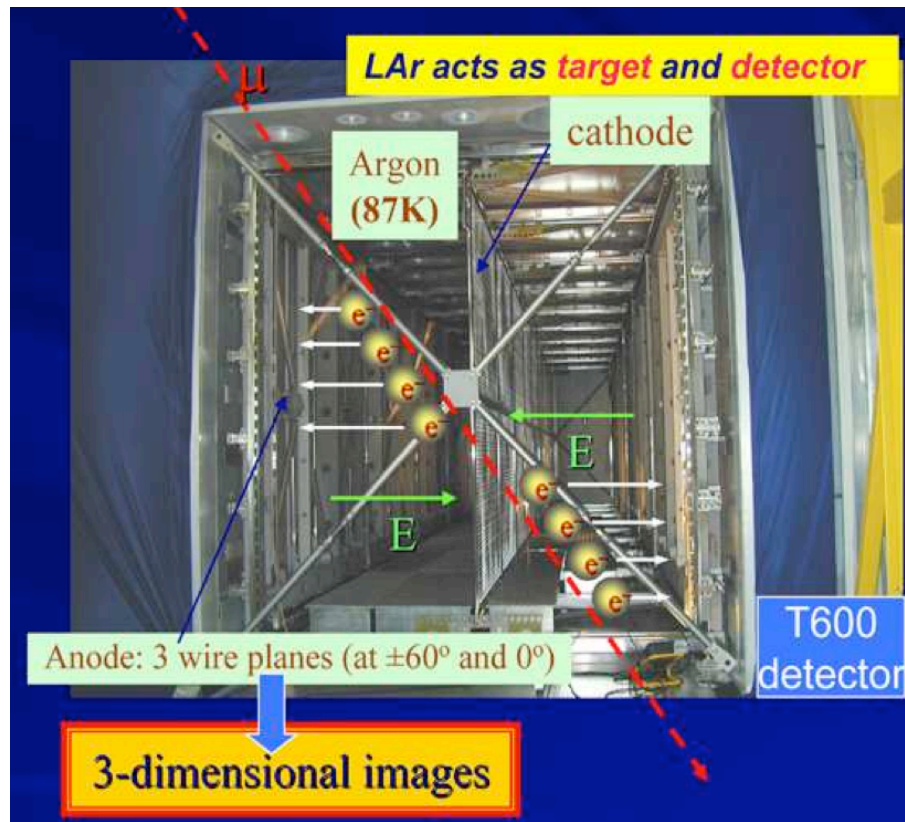

E.m.shower

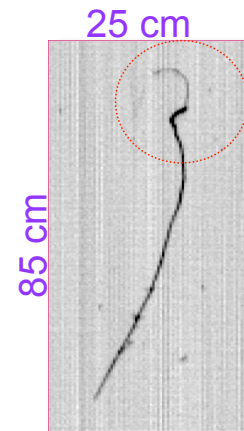
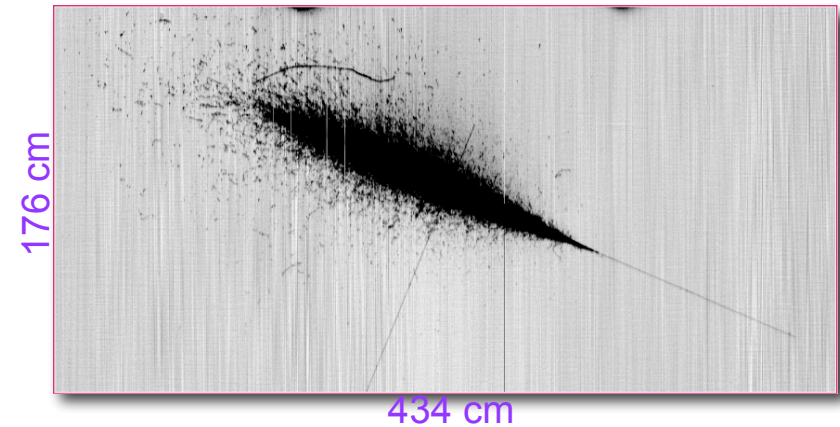

Muon decay

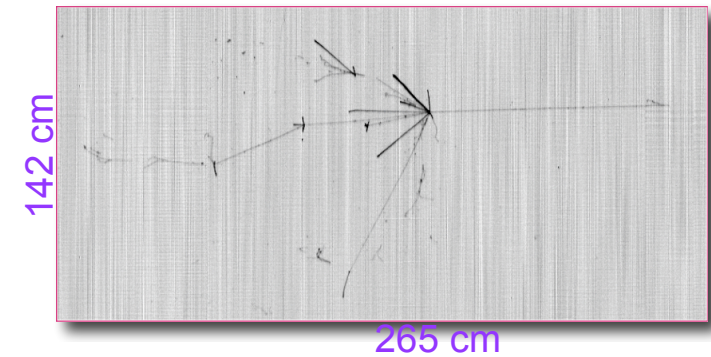

Hadronic interaction

After many years of R&D at lab scale...

The road for the construction of very MASSIVE LAr-TPC is now open!

The LAr-TPC as ν detector

LAr-TPC @ CERN-WANF Phys. Rev. D 74, 112001 (2006)

ν_μ CC-QE

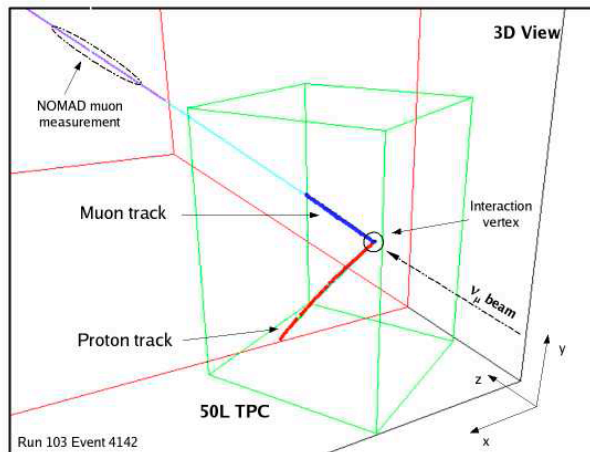
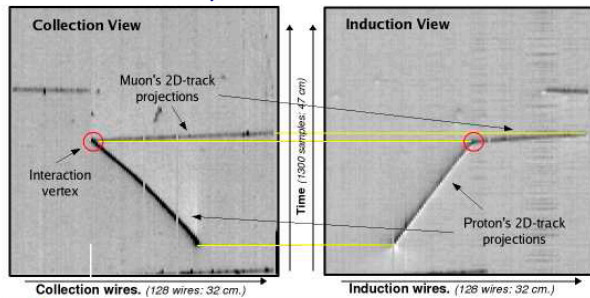

ν_μ CC DIS

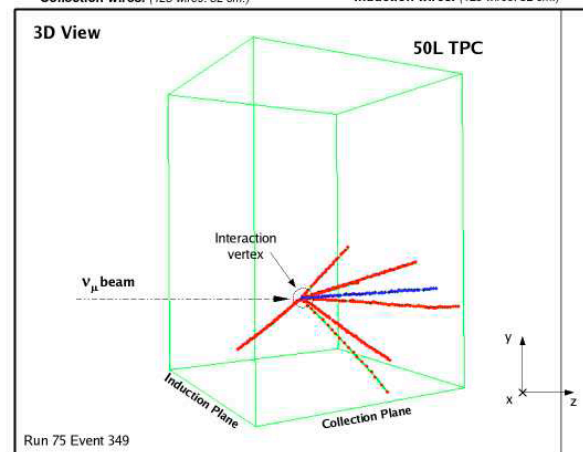
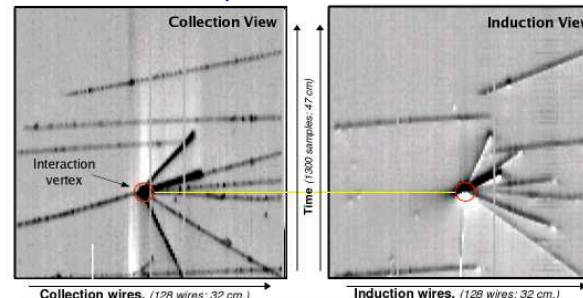

ν_μ CC-RES

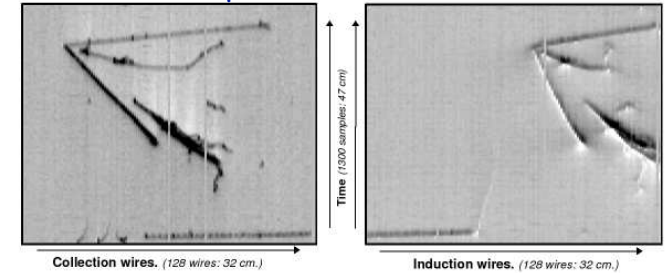

Event is reconstructed as $\nu_\mu n \rightarrow \mu^- \Delta^+ \rightarrow \mu^- p \pi^0$
(a m.i.p. leaving the chamber, an identified stopping proton, a pair of converted γ from π^0 decay)

The LAr-TPC: a detector for ν_e interactions

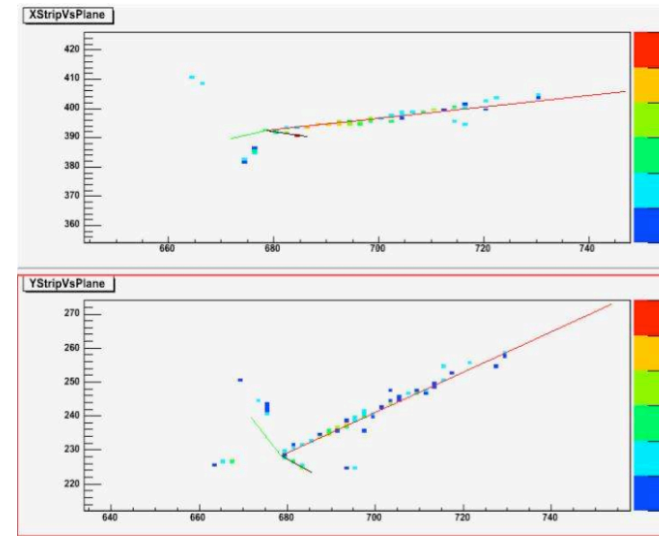
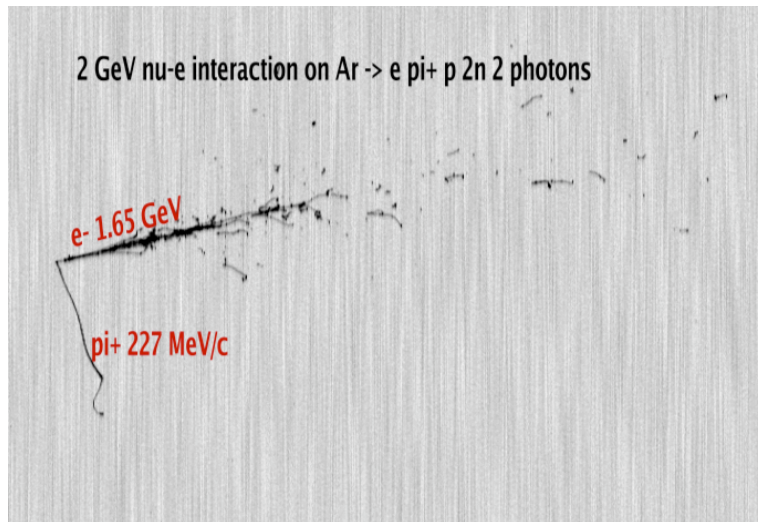

An accepted ν_e charged-current event: $\nu_e A \rightarrow p e \pi^0$, $E_\nu = 1.65$ GeV. See text for explanation.

- Key for $\nu_\mu \rightarrow \nu_e$ event observation: LAr-TPC imaging capability
 - ν_e detection in L. Scint. / Water Č. limited by π^0 NC background
 - NOvA: ν_e detect. effic. $\sim 24\%$, NC indistinguishable from ν_e in a sizable fraction of events \rightarrow increase the background level by $\sim 50\%$ w.r.t. intrinsic ν_e beam contamination
- Much higher discovery potential of LAr w.r.t. L. Scint. / Water Č. detectors:
 - 5 kt of LAr \sim 20 kt of L. Scint. / Water Č !

π^0 background rejection in the LAr-TPC

- *NC π^0 background suppressed by:*
 - *topology (γ conversion from vertex)*
 - *reconstruction of π^0 mass*
 - *electron / photon separation by dE/dx*

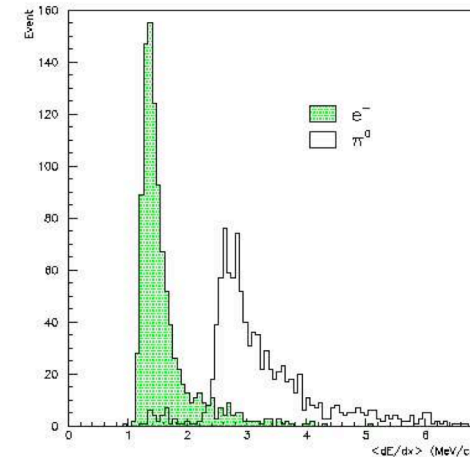
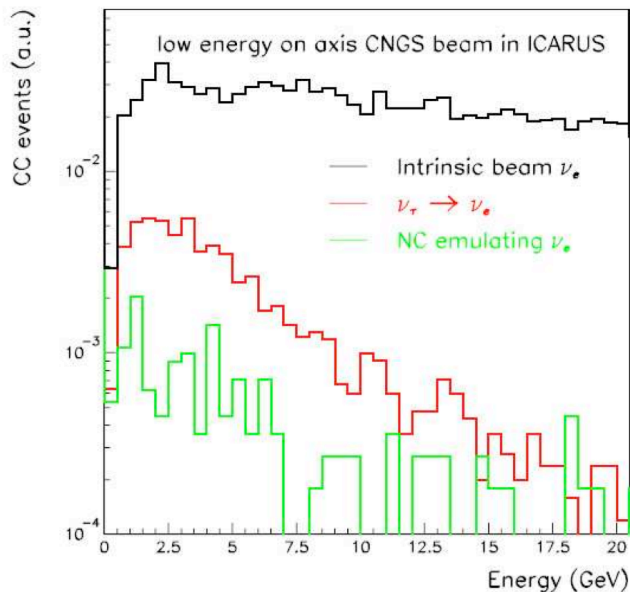
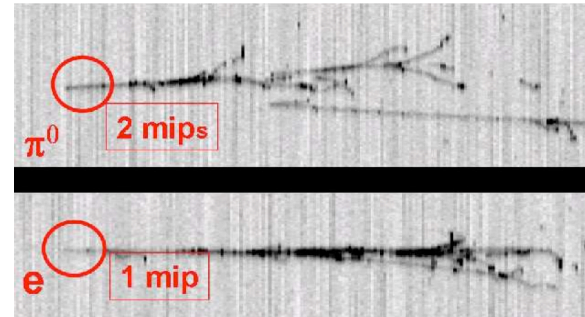

Residual π^0 misidentification < 0.1%
Electron identification \sim 90%



The MODULAr project

Astroparticle Physics 29 (2008) 174–187

- The proposal is focused on three main activities.
 - *A new LAr Imaging detector*, at least initially with about 20 kt fiducial mass, realised with a modular set of four identical, but independent units, each of about 5 kt, “cloning” the basic technology of the T600. Further phases may foresee extensions of MODULAr to a mass required by the future physics goals.
 - *A new experimental area at LNGS*, of at least 50'000 m³ at 10 km off-axis from the main Laboratory, eventually upgradable to larger sizes. A location is under consideration at about 1.2 km equivalent water depth. The bubble chamber like imaging and the very fine calorimetry of the LAr-TPC detector will ensure the best background recognition not only from the off-axis neutrinos from the CNGS but also for proton decay and cosmic neutrinos.
 - *A upgraded neutrino beam* from the CERN 400 GeV proton beam with an horn focussing optics optimized for low energy neutrinos, eventually with an increased intensity in the framework of the LHC accelerator improvement programme.

The new LNGS Halls

- New experimental hall at shallow-depth
 - $50-100 \times 10^3 \text{ m}^3$ (present LNGS halls: $180 \times 10^3 \text{ m}^3$)
 - two sites proposed OUT of Parco Naturale del Gran Sasso and FAR from high-way (NO special safety or environmental limitations !)
 - 10 km Off-Axis w.r.t. present CNGS beam axis
- Site A in Aquilano (Teramo side)
- Site B in Camarda (L'Aquila side)
- Both below 1.2 km eq. water. depth
- Preliminary studies: good rock, no water !
- Site A slightly preferred because of the shortest distance of the tunnel access

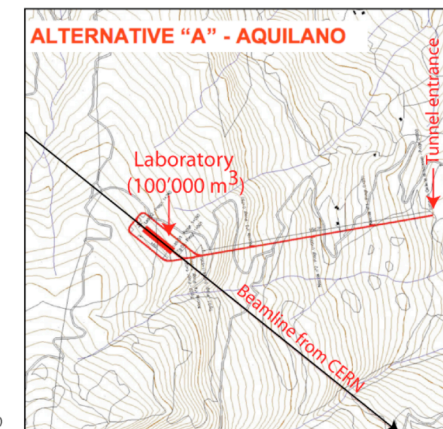
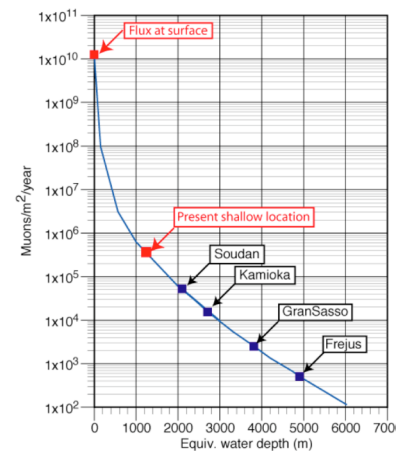
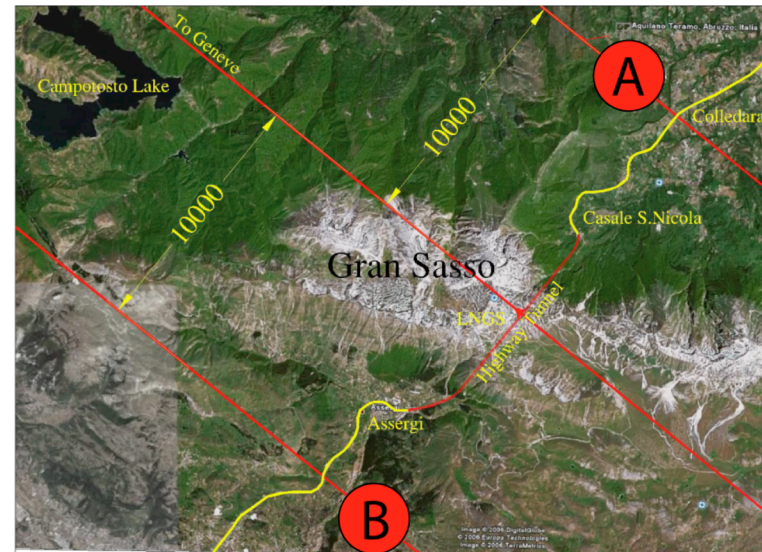

The MODULAR detector

From ICARUS-T600 to a multi-kton LAr-TPC with a modular approach

- MODULAR will be initially composed by four identical module located in the new shallow-depth cavern
- Each module is a scaled-up version of the T600 ($\times 2.66^3$):
 - 8 X 8 m² cross section and about 60 m length
 - LAr active mass: 5370 ton
 - 4 m electron drift
 - 3-D imaging similar to T600 but 6 mm pitch (three wire planes, ~50000 channels)

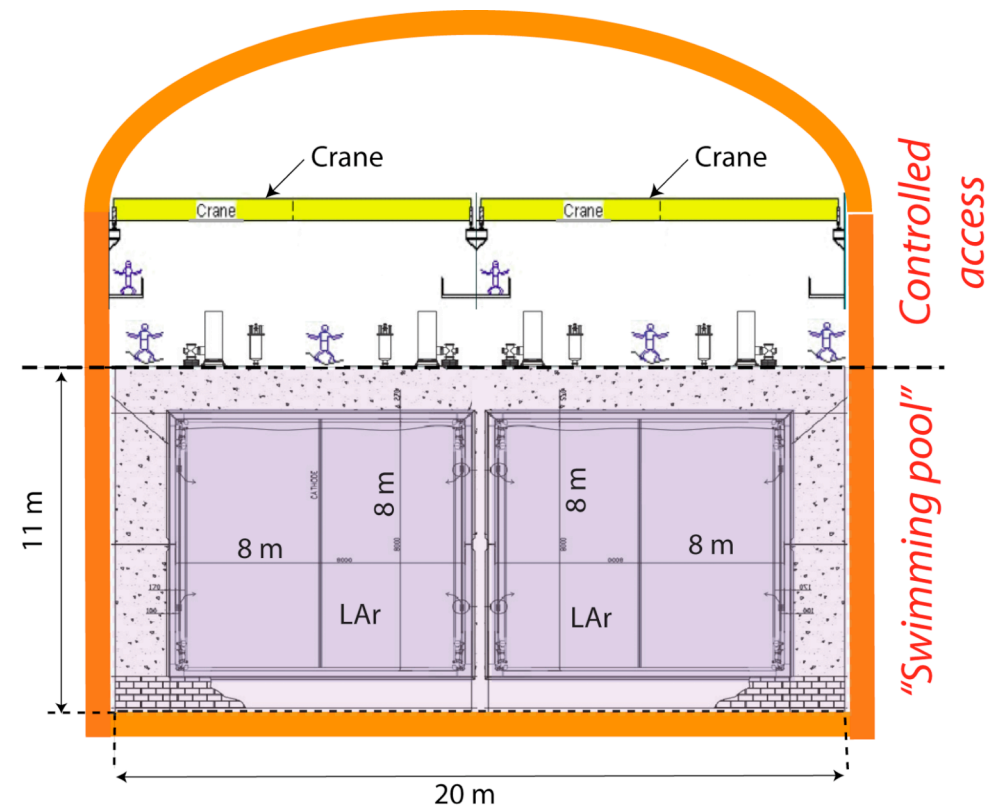



From T600 to MODULAR

- The MODULAR detector will vastly inherit all the achievements of ICARUS-T600:
 - mechanical structure: external insulating vessel (+ PERLITE), a the inner detector supporting structure, LAr an N supply and refrigeration
 - well established and tested wiring technique, replicating that of T600, but with wire length of about 30 m
 - purity < 0.1 ppb (O₂ equiv.) at reach with present techniques (Oxisorb + Hydrosorb + liquid/gas recirculation)
 - H.V.: -200 kV cathode bias ($E_{\text{drift}} = 0.5 \text{ kV/cm}$)
 - 8" PMT's + Wl. Shifter (TPB) for prompt (ns) VUV scintillation light, Q.E. up to 20% working at LAr temperature
 - electronics for 1 module: 50000 channels, new improved design but the same front-end of T600 could also be used !
- Limited R&D is required:
 - Passive insulation (PERLITE), initial air evacuation without vacuum, new electronics architecture...

A new Off-Axis CNGS beam

- 732 km CERN-LNGS, 10 km off-axis (\sim NOvA):
 - E_ν peaked at 2 GeV: *good range for ν x-sections and event reconstruction in LAr.*
- CNGS beam off-axis configuration:
 - *No major improvements of present SPS performance*
 - *512 kW power at 400 GeV: $1.2 \cdot 10^{20}$ pot/year (dedicated mode, 80% live-time)*
 - *New target/optics optimized for low energy*
- *Proton energy: 400 GeV \sim 3.3 x NOvA@FNAL (120 GeV)*
 - *Meson production scales almost linearly with E_p*
 - *What matters is beam power (512 kW @ CNG vs. 768 kW @ NOvA), not proton on target*

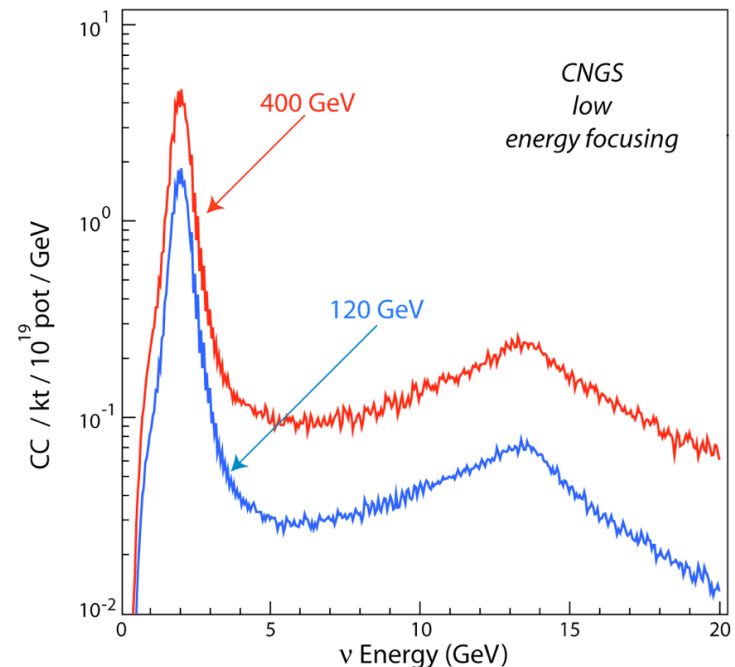

Thank to LAr properties:

MODULAR (20 kt) + CNGS ($1.2 \cdot 10^{20}$ pot/y) \sim NOvA + NUMI ($6.5 \cdot 10^{20}$ pot/y)

T600 as control detector

- There is no near detector at CNGS, however:
 - ICARUS-T600 will be operational on-axis
 - Monte Carlo simulations provide ν_e/ν_μ with few % systematics (checked at WANF)
 - The on-off axis transformation is straightforward
 - A large fraction (60%) of off-axis ν_e comes from π decay
- On-axis, ν_μ can be measured in the $2 < E < 12$ GeV interval, with systematic error from oscillation parameters $\approx 2\%$. **This range accounts for 90% of off-axis ν_μ , and is an almost direct measurement of π generated intrinsic ν_e background (60% of the total ν_e)**
- Off-axis, the K^+ peak in the ν_μ spectrum is located above 10 GeV, where there is NO π contribution. **This is an almost direct measurement of the K^+ generated intrinsic ν_e background (24% of the total ν_e)**

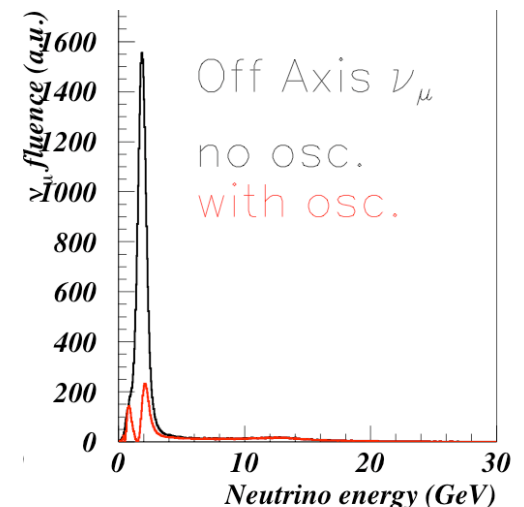
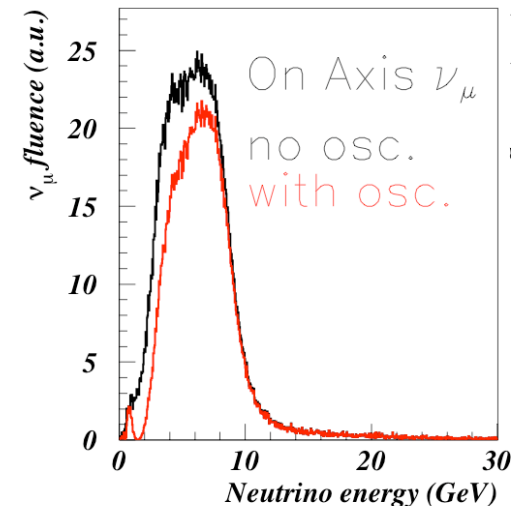

MODULAR

Sensitivity to θ_{13} and δ_{CP}

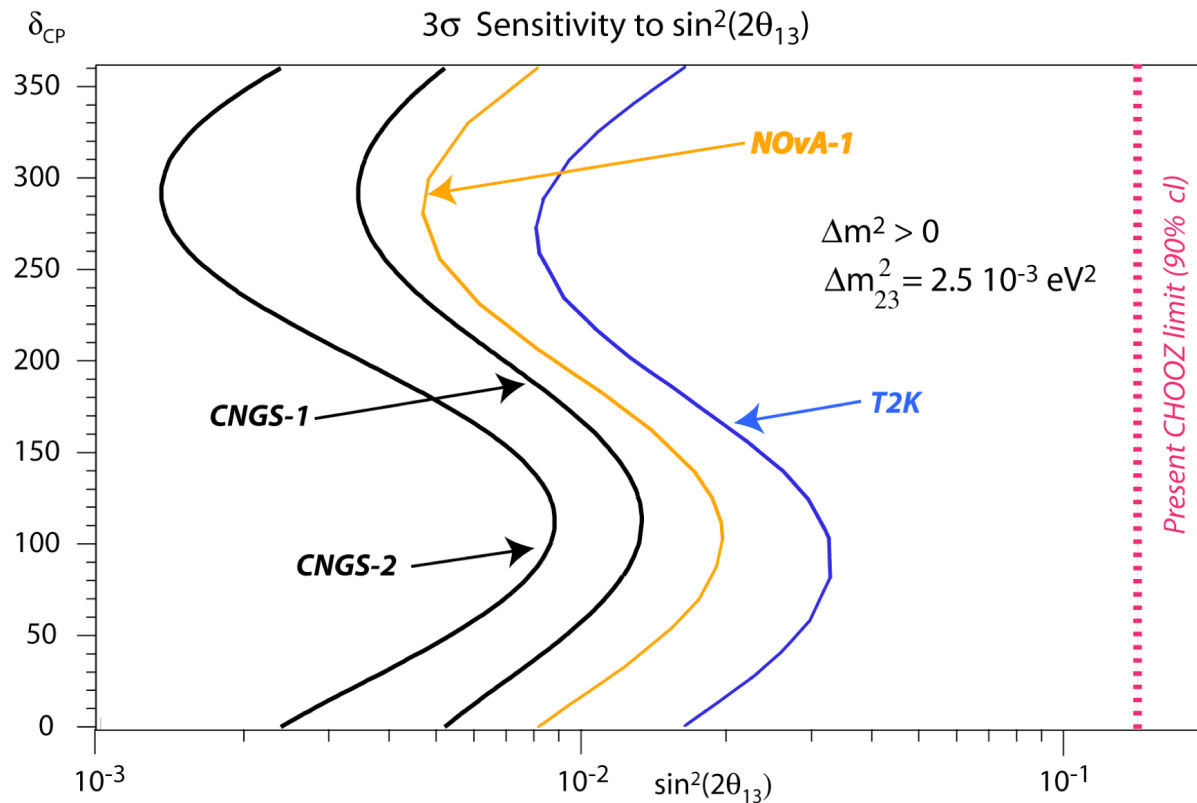

CNGS-1: $1.2 \cdot 10^{20}$ pot/y

CNGS-2: $4.3 \cdot 10^{20}$ pot/y

(Intensity upgrade envisaged improving PS/SPS complex + R&D for 1.6 MW on target)

Exposure:

20 kt x 5 years

GLOBES calculations:

5% beam systematics

$\Delta E/E = 15\%$

Event rates in MODULAR

(20 kt, 5 y, $1.2 \cdot 10^{20}$ pot/y, $\sin^2(2\theta_{13})=0.1$):

ν_{μ} CC	e bgd	Signal	$S/\sqrt{\text{bgd}}$
5700	28	250	47



R&D for MODULAR

- The increase of the active LAr volume of about one order of magnitude with respect to ICARUS-T600, the streamlining and simplification of the mechanical structures and the new developments in the structure of the detector require **some specific R&D developments**.
- These are not of very substantial nature and could be implemented in parallel with the detailed engineering design of MODULAR. They are intended investigate on a small scale the basic innovations introduced with respect to the ICARUS-T600 solutions:
 - the **filling process starting from air to pure LAr**, taking into account the motion of the gas, optimizing the inlet and outlet geometries and minimizing the number of cycles;
 - the **thermal convection of the LAr**, in order to optimize the temperature gradients and to ensure circulation in all regions of the dewar, both in the cool down and stationary phases;
 - the **out-gassing rate and the re-circulation processes** necessary to achieve the required electron lifetime;
 - the **geometry of the compact re-circulators** both in the liquid and in the gaseous phases.
 - finally, also the **electronics and DAQ** may require some specific developments to improve the layout of the analogue front-end and the DAQ architecture.

The SLICE prototype

- A prototype unit of reduced longitudinal dimension, but otherwise identical to the final MODULAR unit.
- Sensitive area of $8 \times 8 \text{ m}^2$ and a depth of $\sim 4 \text{ m}$.
- Sensitive volume of $\sim 264 \text{ m}^3$, or 360 t of LAr, roughly the mass of one T600 semi-module.
- Perlite passive insulation, aluminium inner walls and LN2 cooling.
- No Vacuum before initial LAr filling.
- A GAr and LAr continuous purification (as in T600).
- A pair of three readout planes, one at each side of the gap, a central HV plane (+field shaping rings similar to those used in the ICARUS-T600 LAr-TPC) and a maximum drift distance of 4 m.
- 7700 readout channels for 6 mm wire pitch.
- PMT's, coated with TPB wavelength shifter.
- Electronics outside.

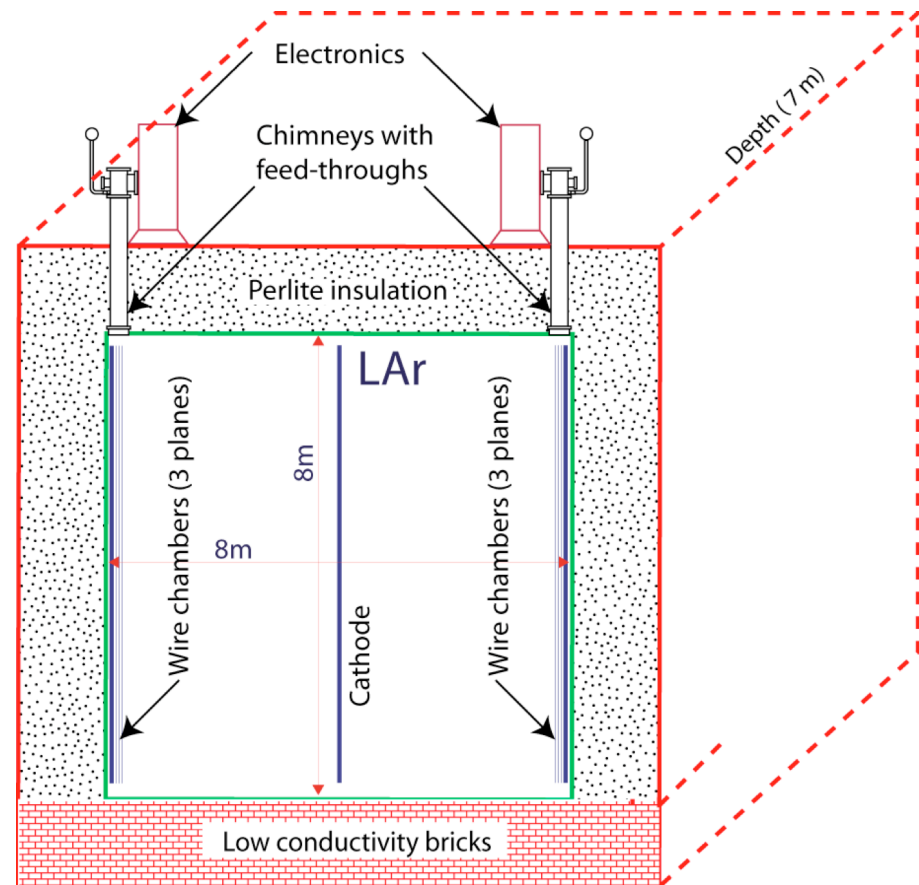

Gar/LAr recirculation system

- Two separated circuits for the liquid and the gaseous phases sized as those of the T600.
 - The first is used for the initial filling with commercial LAr and for its recirculation during ordinary operation, to guarantee an adequate and stable LAr purity.
 - The second, dedicated to the gas phase purification, is meant to eliminate the impurities generated by material out-gassing and possible leaks, thus preventing their diffusion into the liquid.
 - To avoid possible “pockets” of limited circulation and ensure uniform flow, a bottom porous containment plate is envisaged. In the liquid and gaseous transition phase, an appropriate “gutter” structure is conveying uniformly the liquid exiting the volume.

For MODULAR at least 15 sets similar to the SLICE purification system are needed corresponding to the extension from 4 m to 60 m of the depth, to conservatively purify the full volume without saturating the filters.

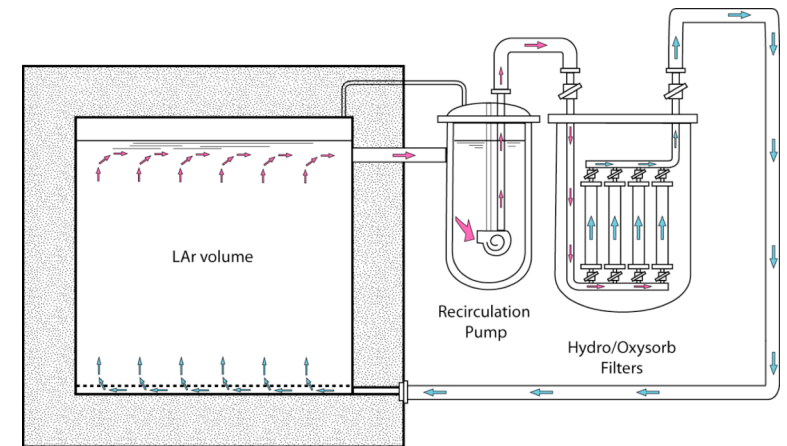

LAr rec.

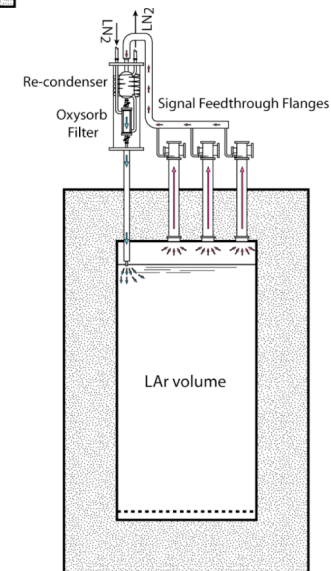

GAr rec.

Air evacuation by Argon flushing

- In the MODULAR, problems may arise due to the magnitude of the volume and the possible appearance of “dead” spots, in which the gas may not circulate.
- Hydrodynamic calculations show that average level of 1 ppm is reached in <6 cycles (~3 days), indicating that the initial evacuation of air through GAR flushing is a viable solution (GAR laminar flow rate = 20 m³ /h in SLICE volume of 256 m³).
- SLICE will be an adequate playground to perfect the method. Simulations, based on 3D modelling and including additional detector details are also envisaged.

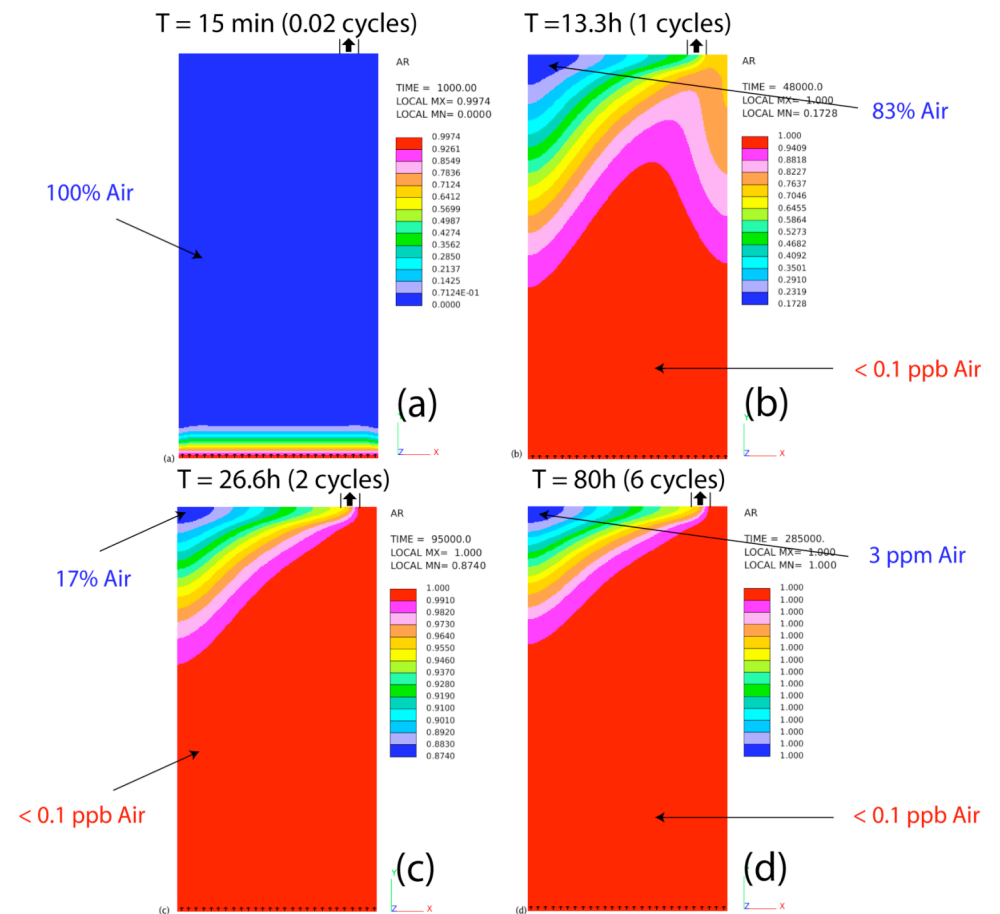

DAQ for MODULAR (and SLICE)

Present **WARM** ICARUS front-end (modulo 32) based on Radeka integrator with input j-FET + multiplexer + FADC's and Serial Link

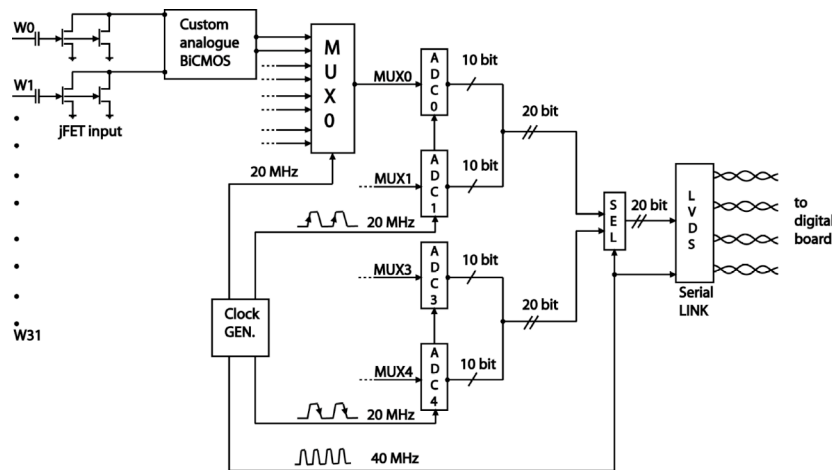

Still a viable solution but ...

Upgraded DAQ scheme: *same basic architecture* with new, better performing components and different modularity (e.g. 576) in view of a multi-kton LAr-TPC

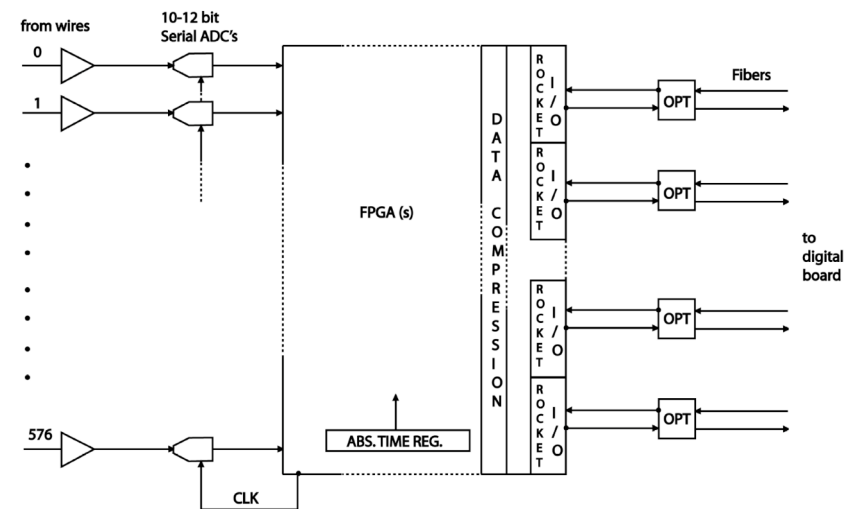

Radeka amplifier + serial ADC's + onboard FPGA' for zero skipping & data reduction + Optical Link

The revised front-end

■ The preamplifier

- The custom IC is based on a Radeka integrator realized in BiCMOS technology, with external input j-FET's.
- A revisited version has been developed, based on the present design, but realized in a much smaller package (4x4 mm²).
- It will allow a higher degree of integration. About $1.4 \cdot 10^5$ dies on sealed silicon wafers are already available.

■ Front-end layout

- New recently developed high density feed-through flange (modulo 576).
- Electronics hosted in a compact crate very close to the feed-through flange. The use of the flange itself as a backplane supporting the analogue boards is under study.
- The number of connectors and cables would be drastically reduced with a benefit for cost and S/N value.

prototype of a four channel amplifier and filter designed with new IC

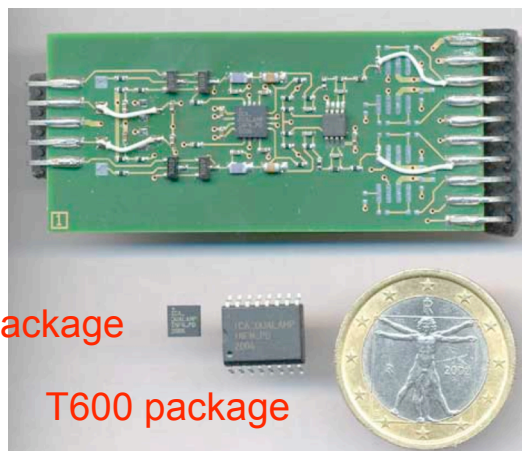

new package

T600 package

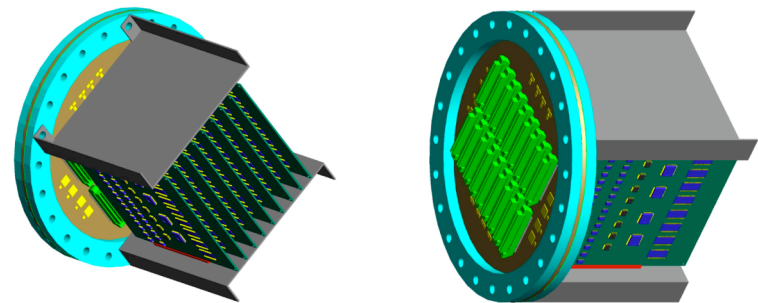



Conclusions

- The forthcoming operation of the T600 detector in the real experiment CNGS-2 will represent the completion of a development of the LAr-TPC chamber over more than two decades and it opens realistically the way to truly massive detectors for accelerator and non accelerator driven phenomena.
- The new 20 kt MODULAR detector will maintain the majority of components already developed by the ICARUS collaboration.
- The main domain of remaining developments, to ensure the correct realization of the new modular elements, is related to the streamlining and simplification of the mechanical structures, to the reduction of the overall costs. It could be tested in a smaller unit (SLICE) with the same cross-section but reduced length and mass.
- The exposure of a 20 kt MODULAR detector to a new CNGS neutrino beam 10 km off-axis will allow exploring with a largely improved sensitivity the $\nu_\mu \leftrightarrow \nu_e$ oscillations.
- The experiment might reasonably be operational in about 5 years, provided a new hall is excavated in the vicinity of the Gran Sasso Laboratory and appropriate funding is made available.
- The realization of the SLICE could also allow carrying out an interesting experimental program in neutrino physics, investigating the existence of sterile neutrinos and measuring neutrino cross-section in the 0–3 GeV energy range.