

CURRENT STATUS OF NEUTRINO MASSES AND MIXINGS

Carlo Giunti

INFN, Sez. di Torino, and Dip. di Fisica Teorica, Università di Torino
giunti@to.infn.it

FACTS

Solar $\nu_e \rightarrow \nu_\mu, \nu_\tau$

Atmospheric $\nu_\mu \rightarrow \nu_\tau$

Atmospheric and Long-Baseline

ν_e Oscillations are Suppressed

Suppressed Short-Baseline

ν_e and ν_μ Oscillations

$m_{\text{light neutrinos}} \lesssim \text{few eV}$

MYSTERIES

Absolute Scale of Neutrino Masses?

Nature of Neutrinos (Dirac or Majorana)?

LSND $\bar{\nu}_\mu \rightarrow \bar{\nu}_e$?

Active \rightarrow Sterile Transitions?

Number of Massive Neutrinos?

ICHEP 2002, Amsterdam, 24-31 July 2002

MAIN CHARACTERISTICS OF SOLAR ν DATA

Experiment	Reaction	E_{th} (MeV)	Operating Time	$\frac{R^{\text{exp}}}{\overline{R}_{\text{BP2000}}}$
SAGE	$\nu_e + {}^{71}\text{Ga} \rightarrow {}^{71}\text{Ge} + e^-$	0.233	1990 – 2001	0.54 ± 0.05
GALLEX			1991 – 1997	0.61 ± 0.06
GNO			1998 – 2000	0.51 ± 0.08
Homestake	$\nu_e + {}^{37}\text{Cl} \rightarrow {}^{37}\text{Ar} + e^-$	0.814	1970 – 1994	0.34 ± 0.03
Kamiokande	$\nu_e + e^- \rightarrow \nu_e + e^-$	6.75	1987 – 1995 2079 days	0.55 ± 0.08
Super-Kam.			1996 – 2001 1496 days	0.465 ± 0.015
SNO	$\nu_e + d \rightarrow p + p + e^-$	6.9	1999 – 2002 306.4 days	0.35 ± 0.02
				$\nu + d \rightarrow p + n + e^-$
	$\nu + e^- \rightarrow \nu + e^-$	5.2		0.47 ± 0.05

$$\Phi_{\text{hep}} < 7.9 \Phi_{\text{hep}}^{\text{SSM}} \quad (90\% \text{ CL})$$

[Smy (SK), Neutrino 2002]

$$A_{\text{ND}}^{\text{SK}} = 0.021 \pm 0.024$$

[SK, PLB 539 (2002) 179]

$$A_{\text{ND}}^{\text{SNO}} = 0.070 \pm 0.051$$

[SNO, PRL 89 (2002) 011302]

SK & SNO \implies no spectral distortion

SK \implies no seasonal variation

SK & SNO \implies very small night-day asymmetry

THE TRIUMPH OF SNO

Sudbury Neutrino Observatory, 1 kton of D₂O, $T_{\text{eff}} \geq 5 \text{ MeV} \Rightarrow \nu_{8\text{B}}$

C $\nu_e + d \rightarrow p + p + e^-$ $E_{\nu}^{\text{th}} \simeq 6.9 \text{ MeV}$

C $\nu + d \rightarrow p + n + \nu$ $E_{\nu}^{\text{th}} \simeq 2.2 \text{ MeV}$

S $\nu + e^- \rightarrow \nu + e^-$ $E_{\nu}^{\text{th}} \simeq 5.2 \text{ MeV}$

assuming no spectral distortions

$$R_{\text{CC}}^{\text{SNO}} \equiv \Phi_{\text{CC}}^{\text{SNO}} / \Phi_{\nu_e}^{\text{SSM}} = 0.35 \pm 0.02$$

$$R_{\text{NC}}^{\text{SNO}} \equiv \Phi_{\text{NC}}^{\text{SNO}} / \Phi_{\nu_e}^{\text{SSM}} = 1.01 \pm 0.13$$

$$R_{\text{ES}}^{\text{SNO}} \equiv \Phi_{\text{ES}}^{\text{SNO}} / \Phi_{\nu_e}^{\text{SSM}} = 0.47 \pm 0.05$$

[SNO, PRL 89 (2002) 011301]

EVIDENCE OF $\nu_e \rightarrow \nu_{\mu}, \nu_{\tau} \implies$ MIXING!

$$\Phi_{\nu_e} = \Phi_{\text{CC}}^{\text{SNO}} = (1.76 \pm 0.11) \times 10^6 \text{ cm}^{-2} \text{ s}^{-1}$$

$$\Phi_{\nu_{\mu}, \nu_{\tau}} = \Phi_{\text{NC}}^{\text{SNO}} - \Phi_{\text{CC}}^{\text{SNO}}$$

$$= (3.33 \pm 0.65) \times 10^6 \text{ cm}^{-2} \text{ s}^{-1} \quad (5.1\sigma)$$

APPEARANCE EXPERIMENT !

Super-Kamiokande

22.5 ktons of H₂O, $E_{\nu}^{\text{th}} \simeq 4.75 \text{ MeV} \Rightarrow \nu_{8\text{B}}$

$$R_{\text{ES}}^{\text{SK}} \equiv \Phi_{\text{ES}}^{\text{SK}} / \Phi_{\nu_e}^{\text{SSM}} = 0.465 \pm 0.015 \quad [\text{SK, PLB 539 (2002) 179}]$$

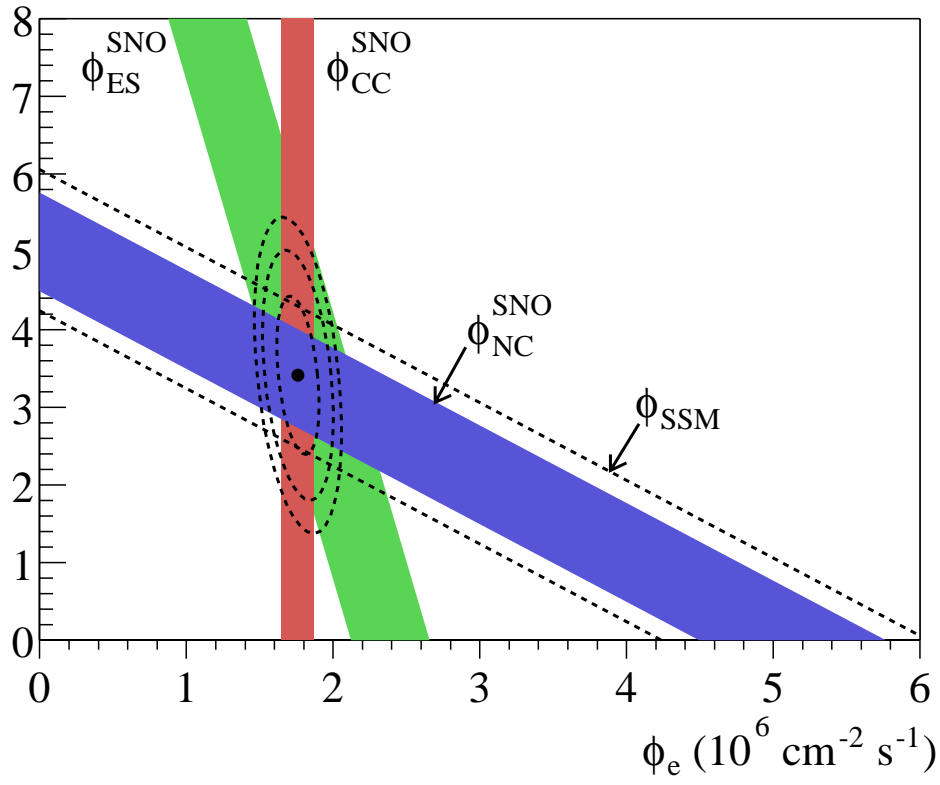

[SNO, PRL 89 (2002) 011301]

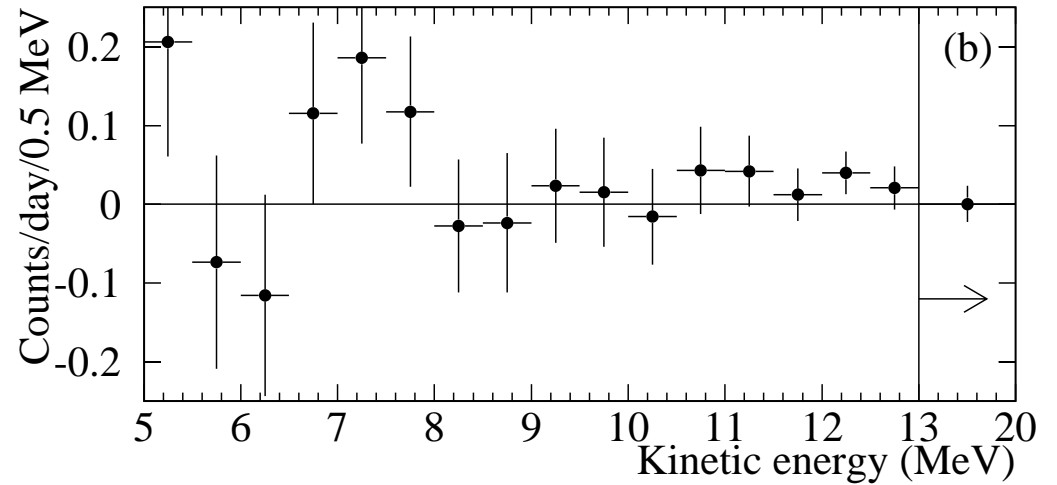
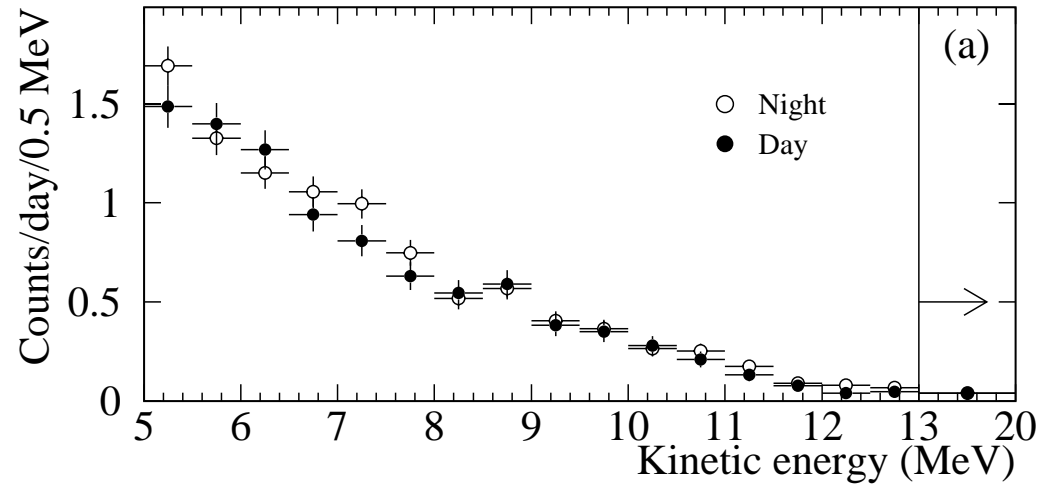

[SNO, PRL 89 (2002) 011302]

$$\Phi_{\nu_e} = (1.76 \pm 0.11) \times 10^6 \text{ cm}^{-2} \text{ s}^{-1}$$

$$\Phi_{\nu_\mu, \nu_\tau} = (3.41 \pm 0.65) \times 10^6 \text{ cm}^{-2} \text{ s}^{-1}$$

$$\Phi_{\nu_e, \nu_\mu, \nu_\tau} = (5.09 \pm 0.64) \times 10^6 \text{ cm}^{-2} \text{ s}^{-1}$$

$$\Phi_{8B}^{\text{SSM}} = (5.05^{+1.01}_{-0.81}) \times 10^6 \text{ cm}^{-2} \text{ s}^{-1}$$

NO SOLVED SOLAR NEUTRINO PROBLEM

(if no future surprises!)

NEUTRINO PHYSICS

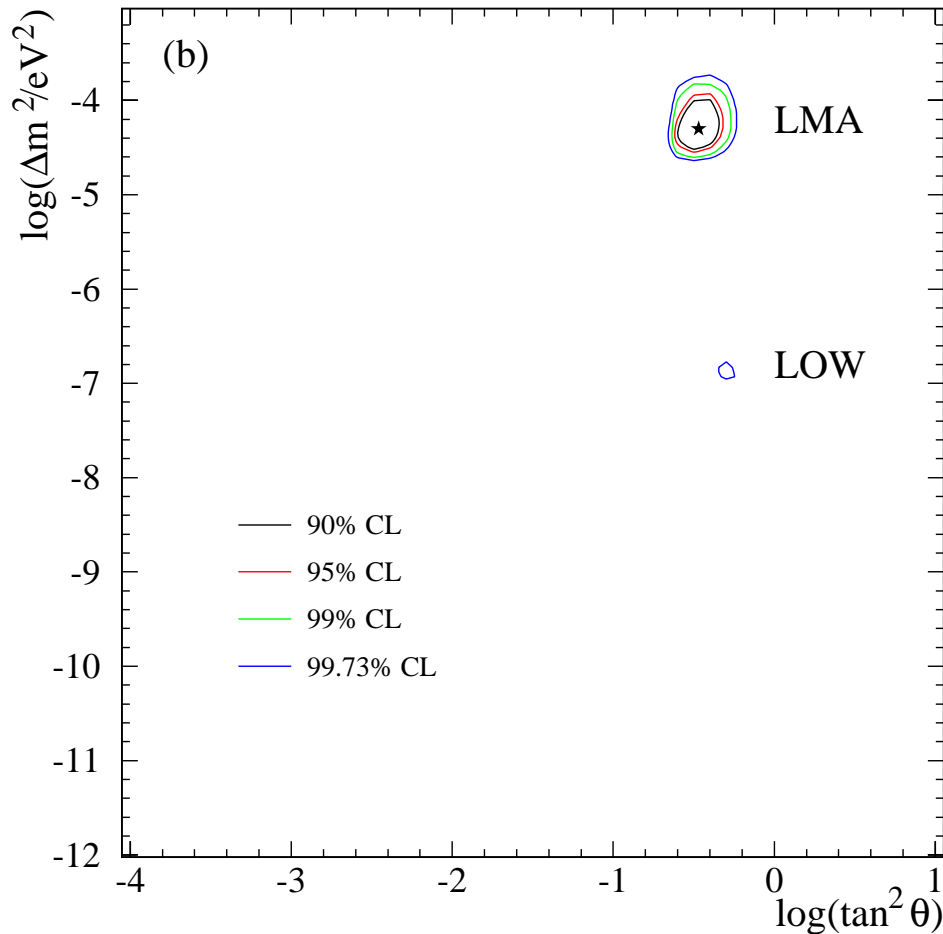

OKKAM'S RAZOR

CONSIDER SIMPLEST HYPOTHESIS

$\nu_e \rightarrow \nu_\mu, \nu_\tau$ oscillations

Large Mixing Angle solution

LMA

$$\Delta m^2 \simeq 5.0 \times 10^{-5} \text{ eV}^2$$

$$\tan^2 \vartheta \simeq 0.34$$

[SNO, PRL 89 (2002) 011302]

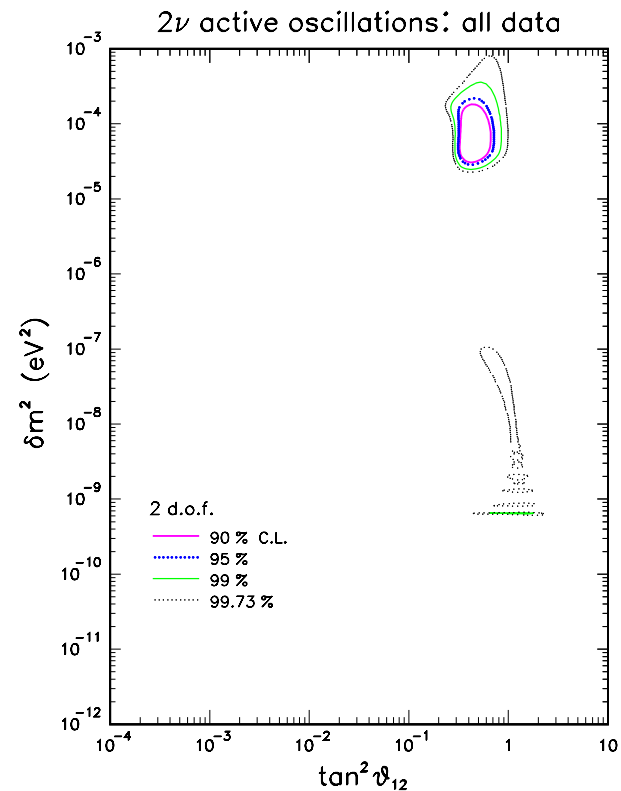
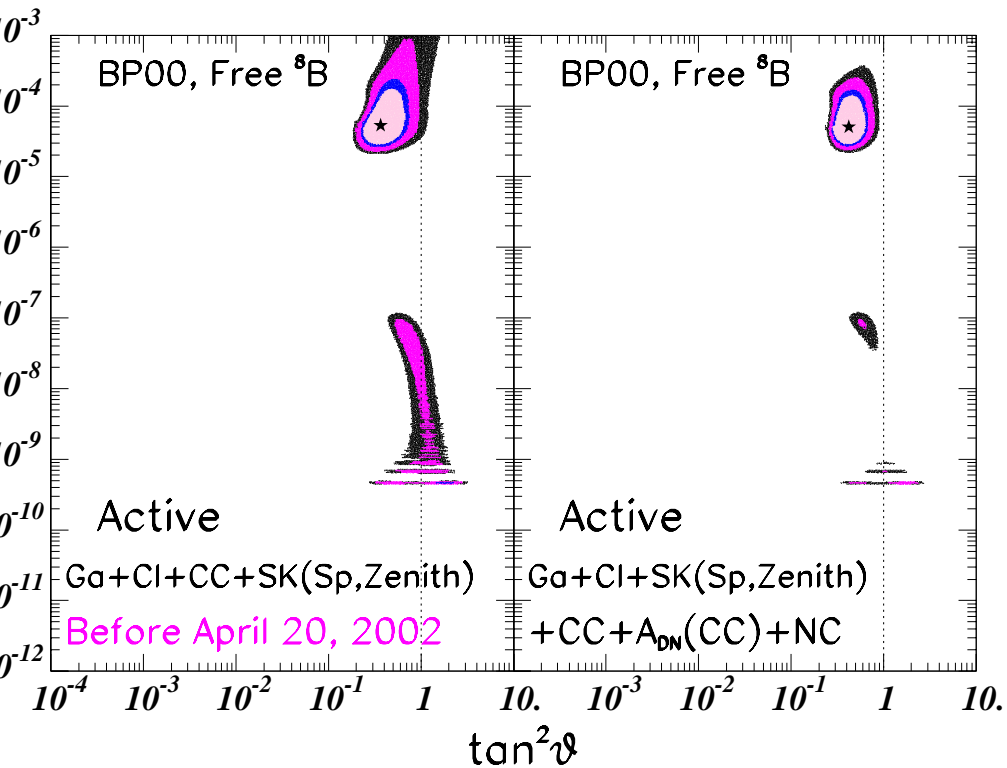

[Bahcall, Gonzalez-Garcia, Peña-Garay, hep-ph/0204314]

[Fogli, Lisi, Marrone, Montanino, Palazzo, hep-ph/0206162]

LARGE MIXING BUT MAXIMAL MIXING IS DISFAVORED!

LMA $0.24 < \tan^2 \vartheta < 0.89$ $2.3 \times 10^{-5} < \Delta m^2 < 3.7 \times 10^{-4}$

LOW $0.43 < \tan^2 \vartheta < 0.86$ $3.5 \times 10^{-8} < \Delta m^2 < 1.2 \times 10^{-7}$

99.73% CL

[Bahcall, Gonzalez-Garcia, Peña-Garay, hep-ph/0204314]

FUTURE: KamLAND (LMA), BOREXINO (LOW), ...

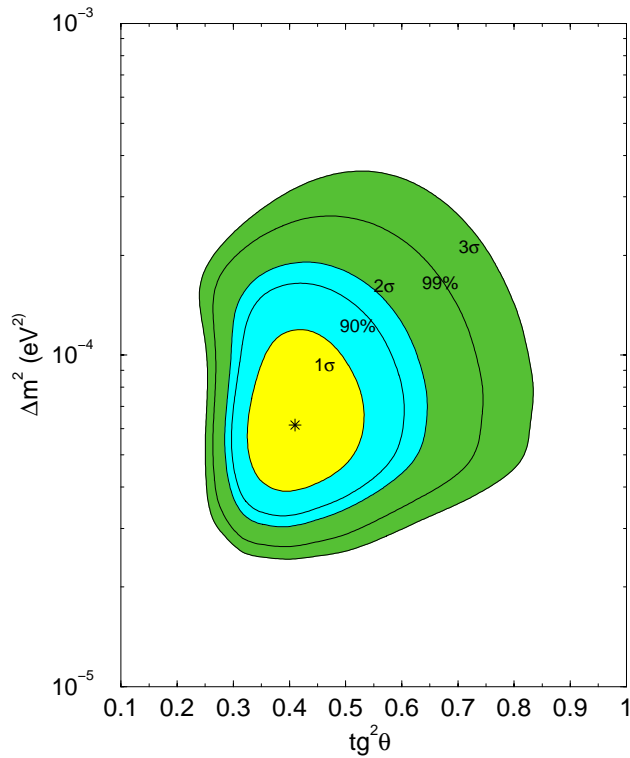

$$0.2 < \tan^2 \vartheta < 0.84$$

$$2.3 \times 10^{-5} < \Delta m^2 < 3.6 \times 10^{-4}$$

99.73% CL

[de Holanda, Smirnov, hep-ph/0205241]

see also

[Barger, Marfatia, Whisnant, Wood, PLB 537 (2002) 179]

[Bandyopadhyay et al., hep-ph/0204286]

[Aliani et al., hep-ph/0205053]

[Creminelli, Signorelli, Strumia, hep-ph/0102234]

[Maltoni, Schwetz, Tortola, Valle, hep-ph/0207227]

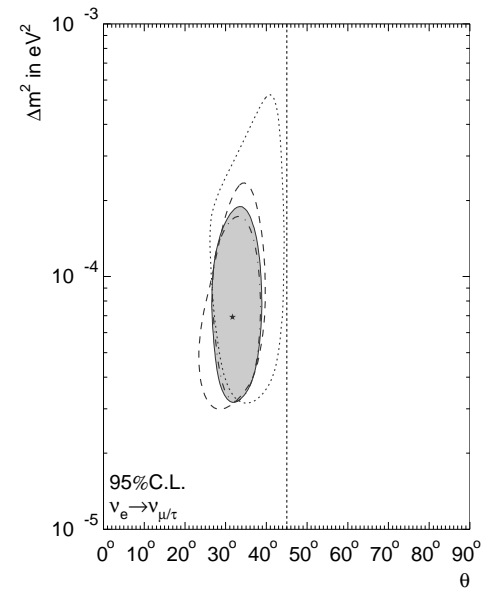
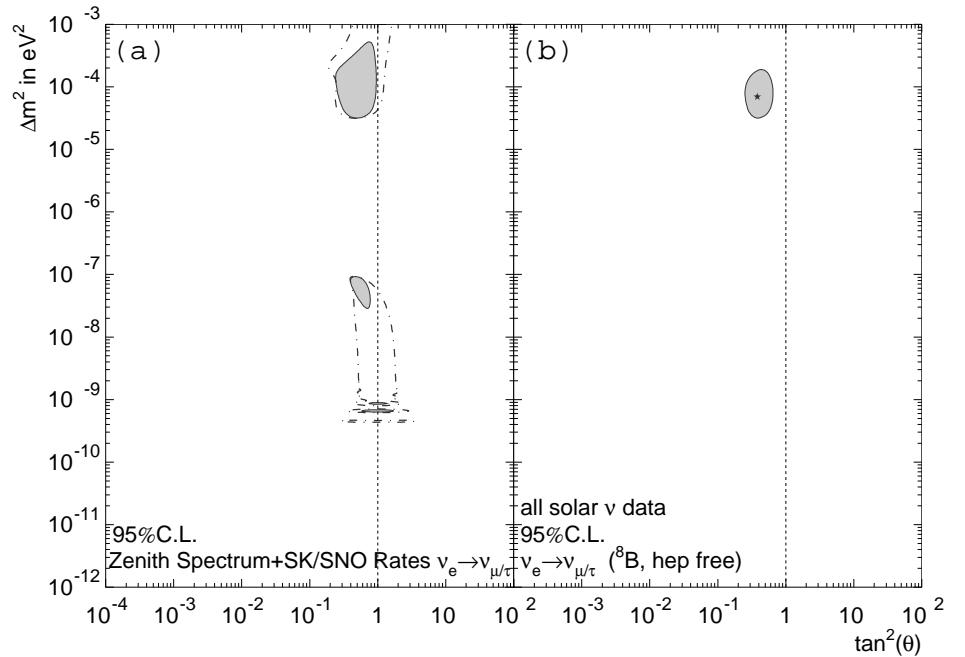

[SK, PLB 539 (2002) 179]

worry: **LOW** is disfavored because **LMA** fit is too good!

$$\text{dof} = 72 = 17 + 17(\text{SNO}) + 19 + 19(\text{SK}) + 3(\text{HOM} + \text{GAL} + \text{SAG}) - 3(\Delta m^2 + \tan^2 \vartheta + \Phi_{8\text{B}})$$

LMA $\chi_{\min}^2 = 57.0$ $\Delta m^2 = 5.0 \times 10^{-5} \text{ eV}^2, \tan^2 \vartheta = 0.34$

LOW $\chi_{\min}^2 = 67.7$ $\Delta m^2 = 1.3 \times 10^{-7} \text{ eV}^2, \tan^2 \vartheta = 0.55$

[SNO, PRL 89 (2002) 011302]

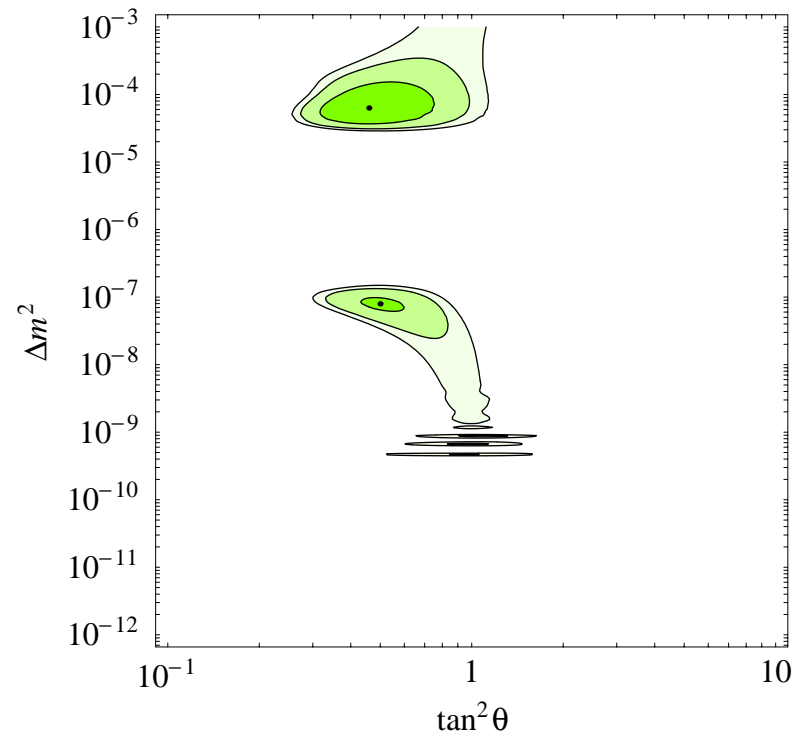
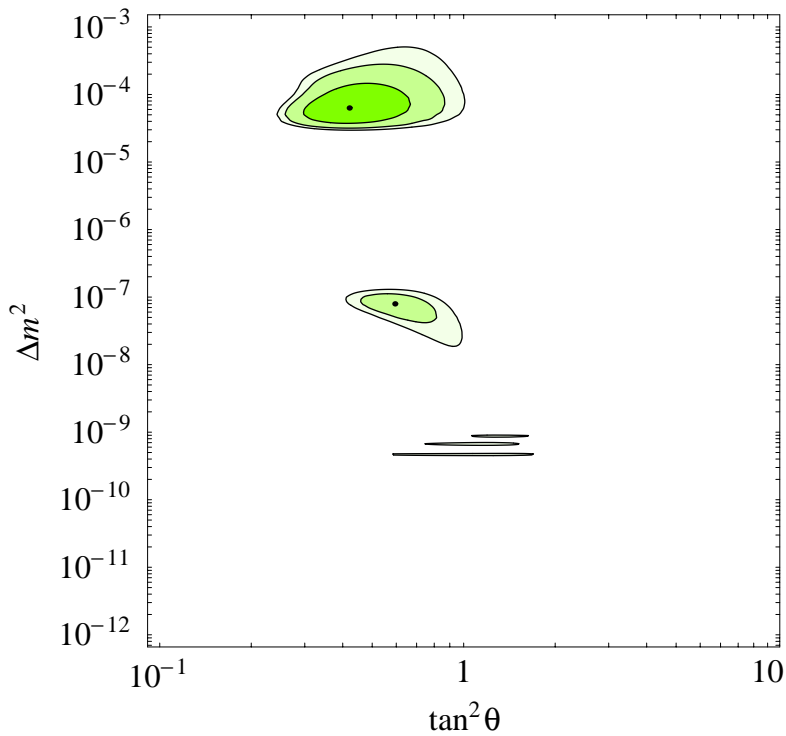

$$R_{\text{Ga}}^{\text{exp}} = 70.8 \pm 4.4 \text{ SNU (1990-2001)}$$

90%, 99%, 99.73% CL

$$R_{\text{Ga}}^{\text{exp}} = 66.1 \pm 5.3 \text{ SNU (1998-2001)}$$

[Strumia, Cattadori, Ferrari, Vissani, hep-ph/0205261]

ATMOSPHERIC NEUTRINOS

Super-Kamiokande Up-Down asymmetry: $A_\mu = \left(\frac{U-D}{U+D} \right)_\mu = -0.311 \pm 0.043 \pm 0.01 \quad (7\sigma)$

Atmospheric Allowed Region

Disappearance of μ -type, no appearance of e -type: $\nu_\mu \rightarrow \nu_\tau$

Uses all Super-K data sets (1290d)

FC, PC, up μ and multi-ring

Very good χ^2 (175.0/190)

Maximal mixing

Smry, UC Irvine

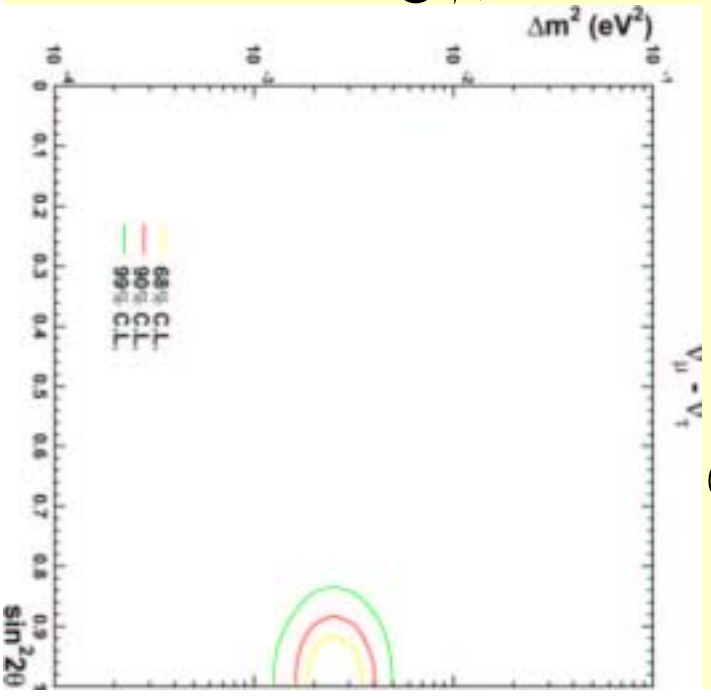

[Smry (SK), Moriond 2002]

Combined allowed regions

May-2002 Neutrino2002 @ Munich

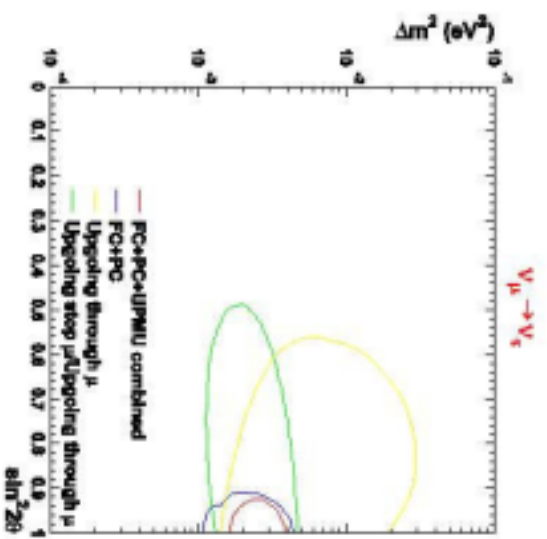

$\nu_\mu \leftrightarrow \nu_\tau$ oscillations

Best fit ($\Delta m^2 = 2.5 \times 10^{-3}, \sin^2 2\theta = 1.0$)

$\chi^2_{\text{min}} = 163.2/170$ d.o.f)

No oscillation

($\chi^2 = 456.5/172$ d.o.f)

$\Delta m^2 = (1.6 \sim 3.9) \times 10^{-3} \text{ eV}^2$

$\sin^2 2\theta > 0.92$ @ 90%CL

[Shiozawa (SK), Neutrino 2002]

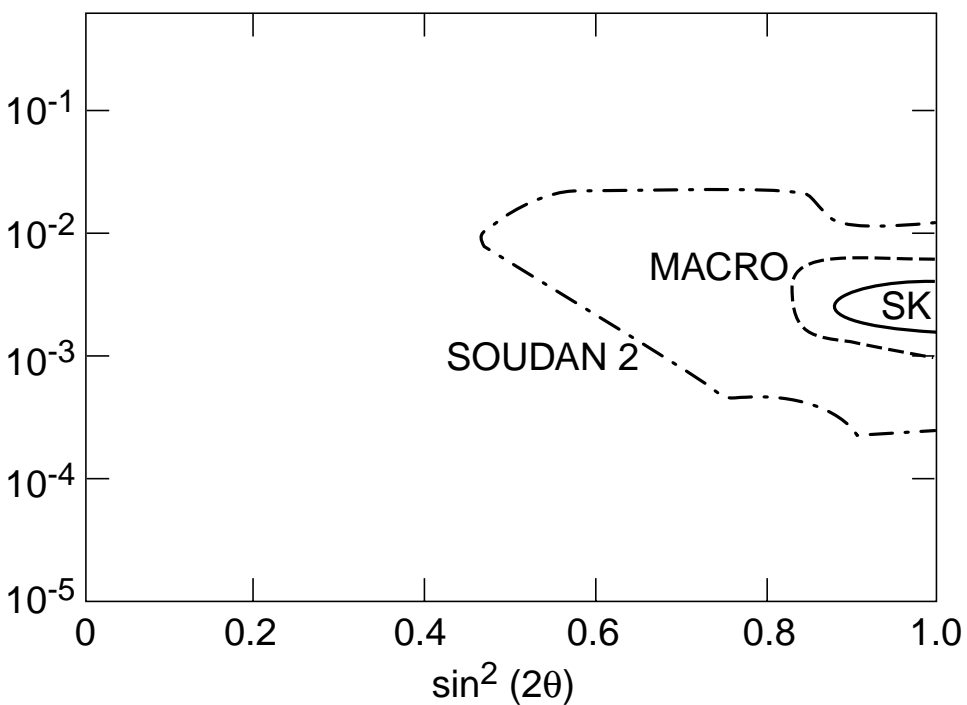
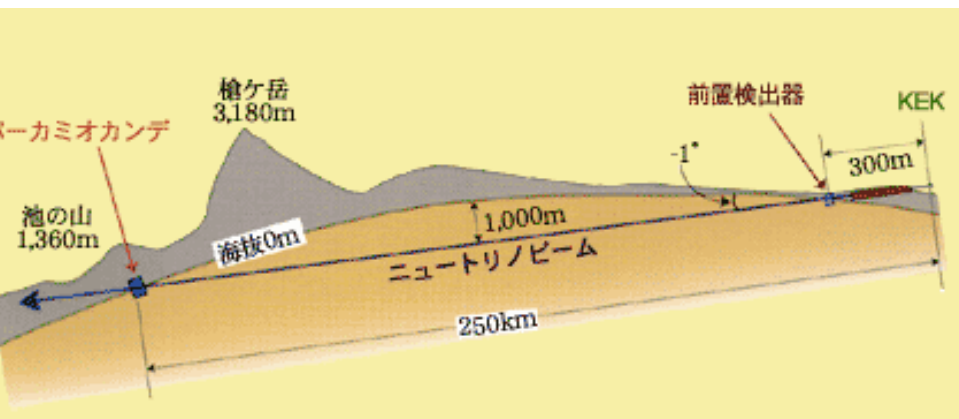

[Giacomelli, Giorgini, Spurio, hep-ex/0201032]

← K2K [<http://neutrino.kek.jp/news/2002.06.12>]

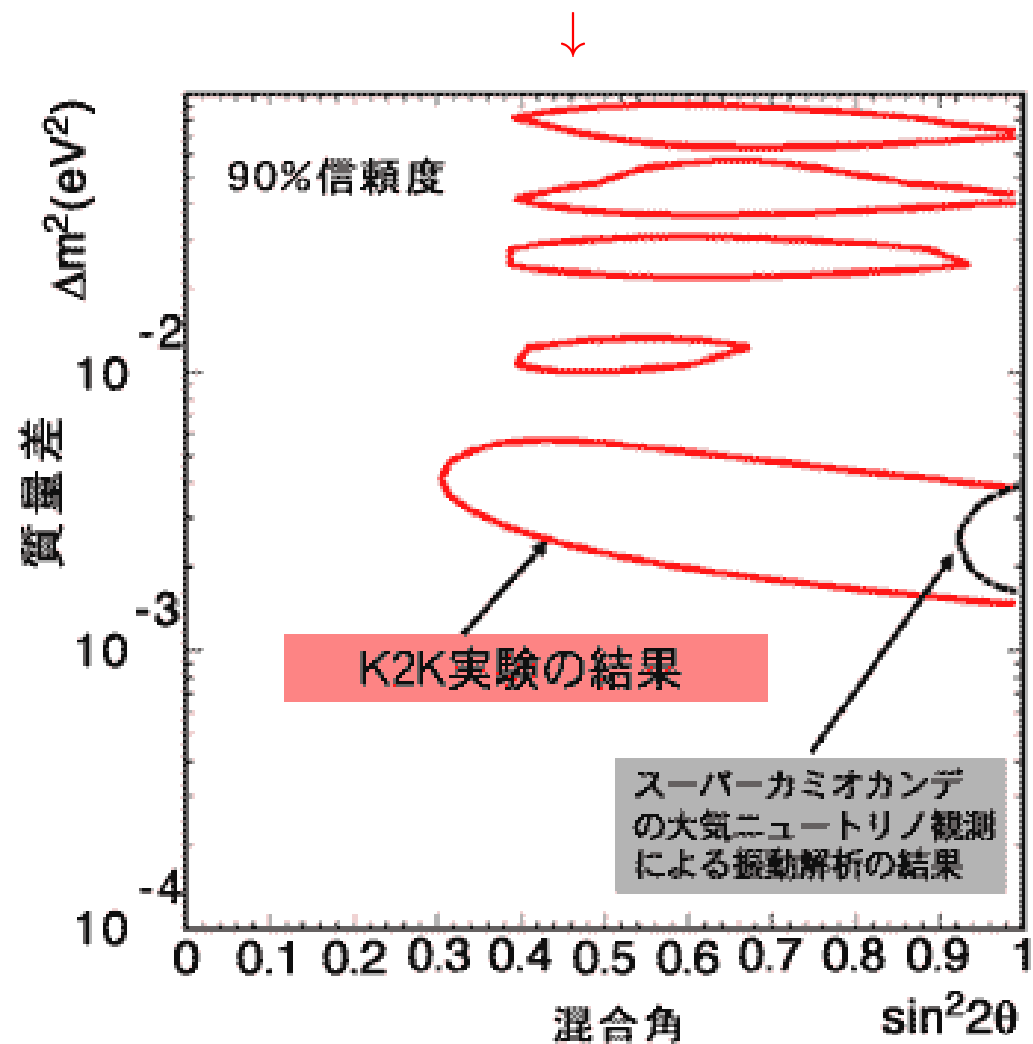

Nature of atmospheric Oscillation

Mode	Best fit	$\Delta\chi^2$	σ
$-V_\tau$	$\sin^2 2\theta=1.00; \Delta m^2=2.5 \times 10^{-3} eV^2$	0.0	0.0
$-V_e$	$\sin^2 2\theta=0.97; \Delta m^2=5.0 \times 10^{-3} eV^2$	79.3	8.9
$-V_s$	$\sin^2 2\theta=0.96; \Delta m^2=3.6 \times 10^{-3} eV^2$	19.0	4.4
E	$\sin^2 2\theta=0.90; \alpha=5.3 \times 10^{-4}$	67.1	8.2
Decay	$\cos^2 2\theta=0.47; \alpha=3.0 \times 10^{-3} eV^2$	81.1	9.0
Decay to V_s	$\cos^2 2\theta=0.33; \alpha=1.1 \times 10^{-2} eV^2$	14.1	3.8

[Smy (SK), Moriond 2002]

FUTURE

K2K: $\nu_\mu \rightarrow \nu_\mu$

MINOS: $\nu_\mu \rightarrow \nu_\mu, \nu_\mu \rightarrow \nu_e, \nu_\mu \rightarrow \nu_{e,\mu,\tau}$ (NC)

CNGS: ICARUS: $\nu_\mu \rightarrow \nu_e, \nu_\mu \rightarrow \nu_\tau$ OPERA: $\nu_\mu \rightarrow \nu_\tau$

limit on $\nu_\mu \leftrightarrow \nu_s$ admixture

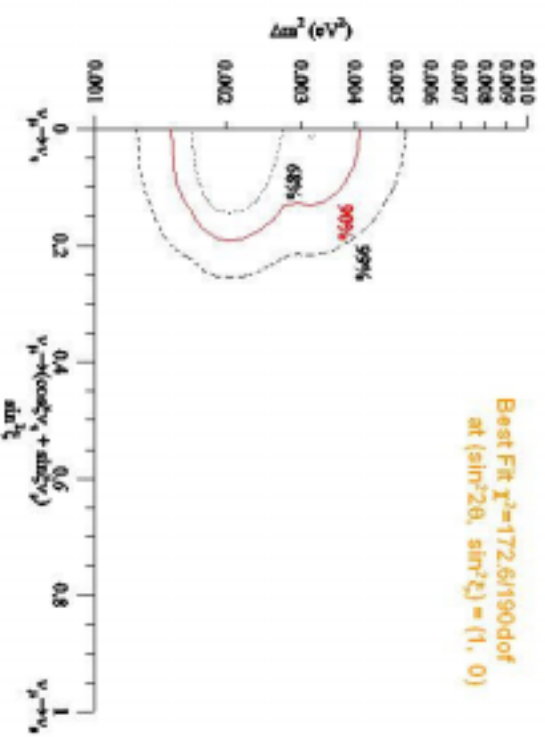

[Shiozawa (SK), Neutrino 2002]

THREE-NEUTRINO MIXING

flavor fields ν_α , $\alpha = e, \mu, \tau$ $\nu_{\alpha L} = \sum_{k=1}^3 U_{\alpha k} \nu_{kL}$ massive fields $\nu_k \rightarrow m_k$

$$\Delta m_{\text{SUN}}^2 = \Delta m_{21}^2 \sim 5 \times 10^{-5} \text{ eV}^2$$

$$\Delta m_{\text{ATM}}^2 \simeq |\Delta m_{31}^2| \sim 2.5 \times 10^{-3} \text{ eV}^2$$

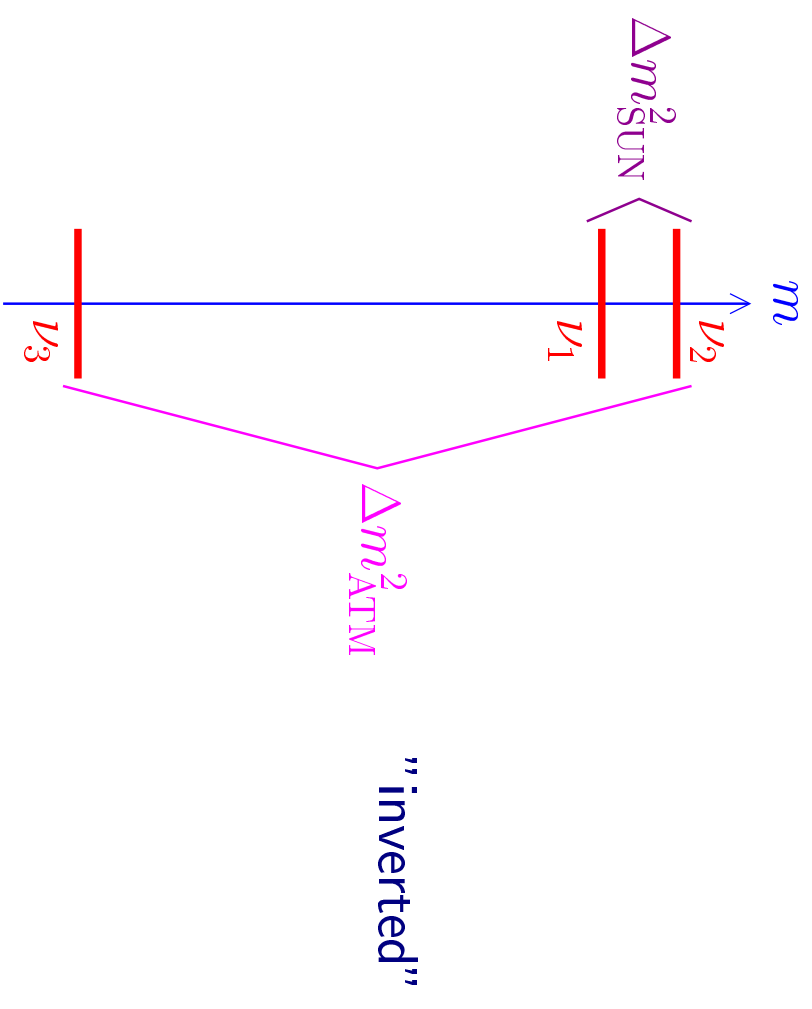
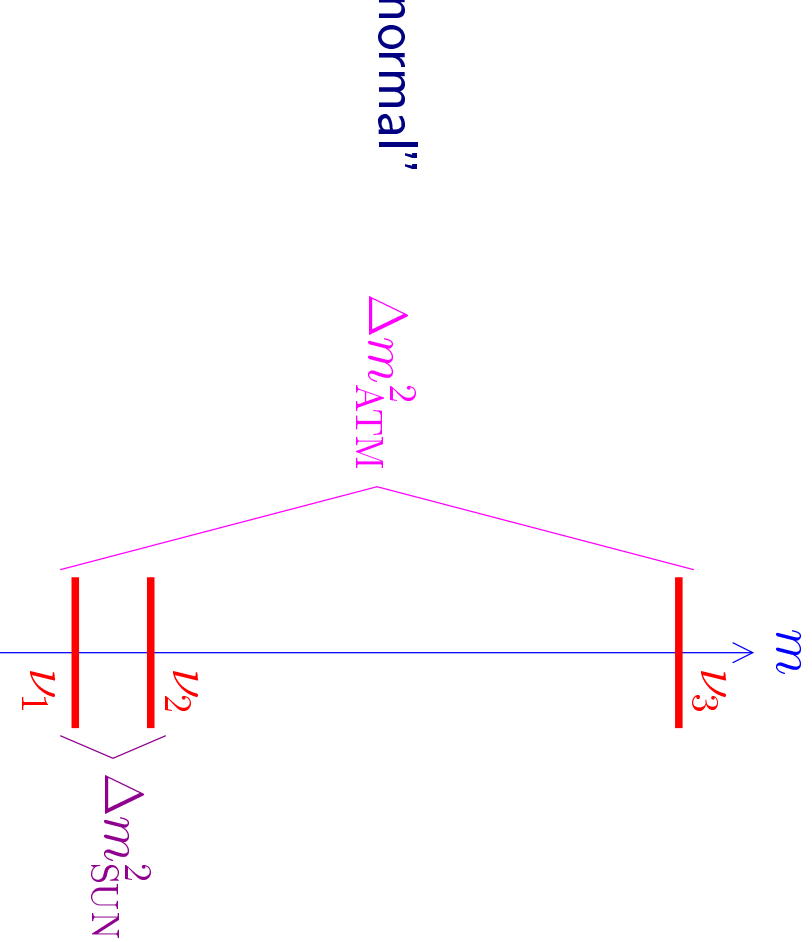

$$\Delta m_{21}^2 \ll |\Delta m_{31}^2|$$

$$U = \begin{pmatrix} U_{e1} & U_{e2} & U_{e3} \\ U_{\mu 1} & U_{\mu 2} & U_{\mu 3} \\ U_{\tau 1} & U_{\tau 2} & U_{\tau 3} \end{pmatrix}$$

SUN → $U_{e1} \ U_{e2} \ U_{e3}$ $U_{\mu 3}$ $U_{\tau 3}$
ATM ↑

CHOOZ:

$$\begin{cases} \Delta m_{\text{CHOOZ}}^2 = \Delta m_{31}^2 = \Delta m_{\text{ATM}}^2 \\ \sin^2 2\vartheta_{\text{CHOOZ}} = 4|U_{e3}|^2(1 - |U_{e3}|^2) \end{cases}$$

$$|U_{e3}|^2 \lesssim 4 \times 10^{-2} \quad \text{for} \quad \Delta m_{\text{ATM}}^2 \simeq 2.5 \times 10^{-3} \text{ eV}^2$$

confirmed by Palo Verde [PRD 64 (2001) 112001]

SOLAR AND ATMOSPHERIC ν OSCILLATIONS
ARE PRACTICALLY DECOUPLED!

TWO-NEUTRINO SOLAR and ATMOSPHERIC ν OSCILLATIONS ARE OK!

$$\sin^2 \vartheta_{\text{SUN}} = \frac{|U_{e2}|^2}{1 - |U_{e3}|^2} \simeq |U_{e2}|^2 \quad \sin^2 \vartheta_{\text{ATM}} = \frac{|U_{\mu 3}|^2}{1 - |U_{e3}|^2} \simeq |U_{\mu 3}|^2 \quad [\text{Bilenky, Giunti, PLB 444 (1998) 379}]$$

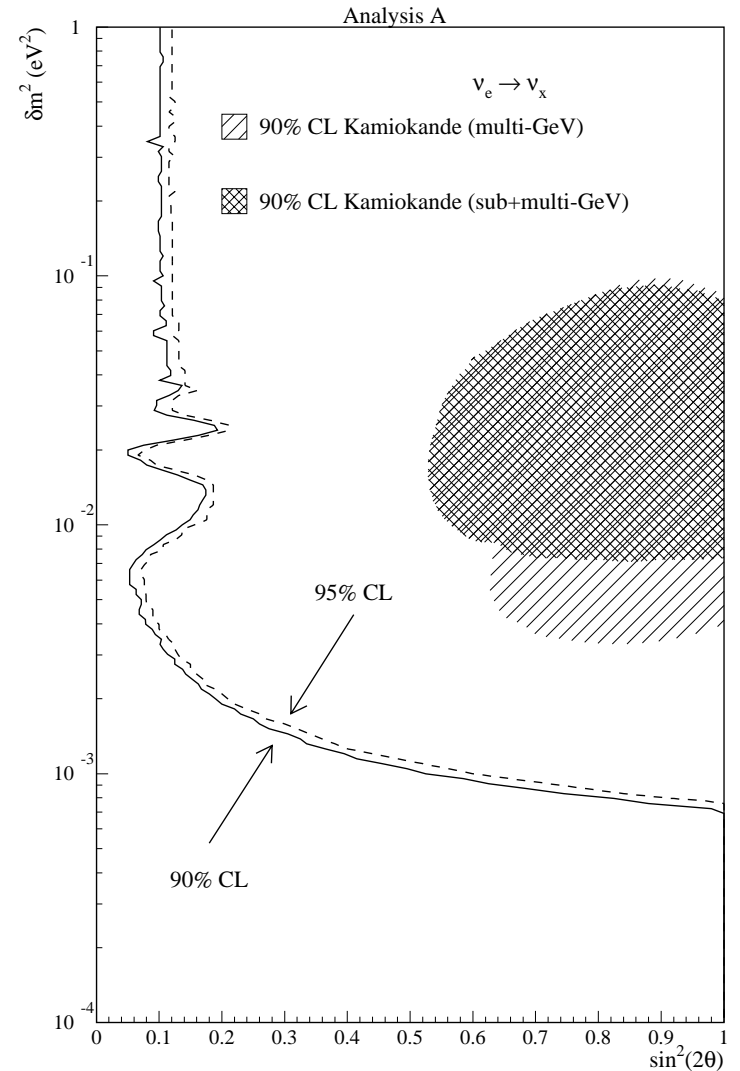

[CHOOZ, PLB 466 (1999) 415]

Allowed region for active 3-flavor oscillations

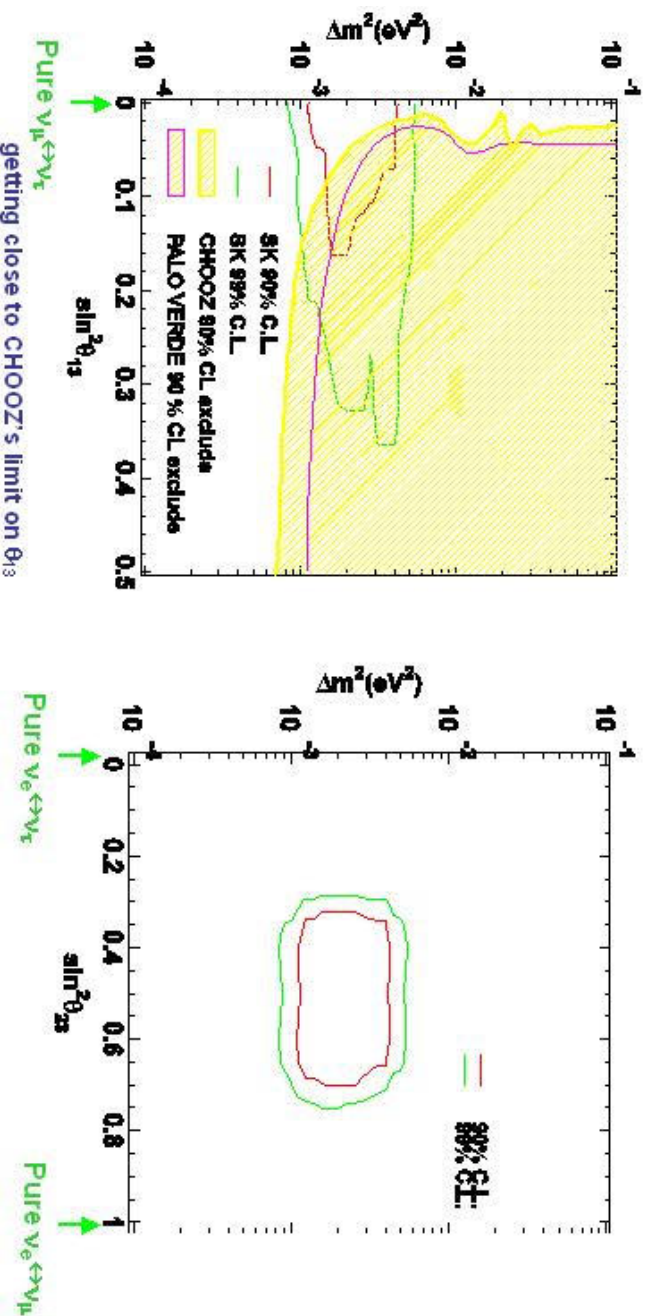

consistent with CHOOZ's excluded region

[Shiozawa (SK), Neutrino 2002]

FUTURE

MINOS: sensitivity $|U_{e3}|^2 \sim 10^{-2}$

JHF-Kamioka: sensitivity $|U_{e3}|^2 \sim 2 \times 10^{-3}$ ($|U_{e3}|^2 \sim 10^{-4}$ with Hyper-Kamiokande) [hep-ex/0106019]

Neutrino Factory: sensitivity $|U_{e3}|^2 \sim 10^{-5}$

$|U_{e3}| > 0 \Rightarrow$ sign of Δm_{31}^2 (Earth matter effects) and (maybe) CP violation

ALMOST BIMAXIMAL MIXING (BILARGE)

$$|U_{e3}|^2 \ll 1 \Rightarrow U \simeq \begin{pmatrix} c_{\vartheta_S} & s_{\vartheta_S} & 0 \\ -s_{\vartheta_S} c_{\vartheta_A} & c_{\vartheta_S} c_{\vartheta_A} & s_{\vartheta_A} \\ s_{\vartheta_S} s_{\vartheta_A} & -c_{\vartheta_S} s_{\vartheta_A} & c_{\vartheta_A} \end{pmatrix} \Rightarrow \begin{cases} \nu_e = c_{\vartheta_S} \nu_1 + s_{\vartheta_S} \nu_2 \\ \nu_a^{(S)} = -s_{\vartheta_S} \nu_1 + c_{\vartheta_S} \nu_2 \\ = c_{\vartheta_A} \nu_\mu - s_{\vartheta_A} \nu_\tau \end{cases}$$

$$\sin^2 2\vartheta_A \simeq 1 \Rightarrow \vartheta_A \simeq \frac{\pi}{4} \Rightarrow U \simeq \begin{pmatrix} c_{\vartheta_S} & s_{\vartheta_S} & 0 \\ -s_{\vartheta_S}/\sqrt{2} & c_{\vartheta_S}/\sqrt{2} & 1/\sqrt{2} \\ s_{\vartheta_S}/\sqrt{2} & -c_{\vartheta_S}/\sqrt{2} & 1/\sqrt{2} \end{pmatrix}$$

$$\text{Solar } \nu_e \rightarrow \nu_a^{(S)} \simeq \frac{1}{\sqrt{2}} (\nu_\mu - \nu_\tau)$$

$$\frac{\Phi_{\text{CC}}^{\text{SNO}}}{\Phi_{\nu_e}^{\text{SSM}}} \simeq \frac{1}{3} \Rightarrow \Phi_{\nu_e} \simeq \Phi_{\nu_\mu} \simeq \Phi_{\nu_\tau} \text{ for } E \gtrsim 6 \text{ MeV}$$

$$\text{LMA} \Rightarrow \tan^2 \vartheta_S \simeq 0.34 \Rightarrow \vartheta_S \simeq \frac{\pi}{6} \Rightarrow U \simeq \begin{pmatrix} \frac{\sqrt{3}}{2} & \frac{1}{2} & 0 \\ -\frac{1}{2\sqrt{2}} & \frac{\sqrt{3}}{2\sqrt{2}} & \frac{1}{\sqrt{2}} \\ \frac{1}{2\sqrt{2}} & -\frac{\sqrt{3}}{2\sqrt{2}} & \frac{1}{\sqrt{2}} \end{pmatrix}$$

DEPARTURE FROM BIMAXIMAL MIXING: EXAMPLE

$$j_p^{\text{GCT}} = 2 \sum_{\alpha'=e',\mu',\tau'} \overline{\ell_{\alpha'L}} \gamma_p \nu_{\alpha'L} \quad \ell_{\alpha'L} = \sum_{\alpha=e,\mu,\tau} V_{\alpha'\alpha}^{(\ell)} \ell_{\alpha L} \quad \nu_{\alpha'L} = \sum_{k=1}^3 V_{\alpha'k}^{(\nu)} \nu_{kL}$$

$$j_p^{\text{GCT}} = 2 \sum_{\alpha,k} \overline{\ell_{\alpha L}} \gamma_p \left(\sum_{\alpha'} V_{\alpha'\alpha}^{(\ell)} * V_{\alpha'k}^{(\nu)} \right) \nu_{kL} = 2 \sum_{\alpha,k} \overline{\ell_{\alpha L}} \gamma_p U_{\alpha k} \nu_{kL}$$

$$U = V^{(\ell)\dagger} V^{(\nu)} \quad \text{bimaximal } V^{(\nu)} = \begin{pmatrix} \frac{1}{\sqrt{2}} & \frac{1}{\sqrt{2}} & 0 \\ -\frac{1}{2} & \frac{1}{2} & \frac{1}{\sqrt{2}} \\ \frac{1}{2} & -\frac{1}{2} & \frac{1}{\sqrt{2}} \end{pmatrix} \quad \text{hierarchical } V^{(\ell)} \text{ like } U_{\text{CKM}}$$

bilarge mixing with $\vartheta_{\text{SUN}} < \pi/4$, $\vartheta_{\text{ATM}} \simeq \pi/4$, $U_{e3} \neq 0$

LMA $\Rightarrow 10^{-3} \lesssim |U_{e3}|^2 \lesssim 4 \times 10^{-2}$ **measurable in JHF-Kamioka**

$$V^{(\ell)} \simeq U_{\text{CKM}} \Rightarrow |U| \simeq \begin{pmatrix} 0.80 & 0.58 & 0.15 \\ 0.35 & 0.66 & 0.66 \\ 0.48 & 0.48 & 0.74 \end{pmatrix} \Rightarrow \tan^2 \vartheta_S \simeq 0.45, \sin^2 2\vartheta_A \simeq 0.99,$$

unfortunately small CP violation: $J \lesssim 4 \times 10^{-3}$ ($J_{\text{max}} = \frac{1}{6\sqrt{3}} = 9.6 \times 10^{-2}$, $J_{\text{max}}^{(\text{quasi-bimax})} \simeq 5 \times 10^{-2}$)

[Giunti, Tanimoto, hep-ph/0207096]

ABSOLUTE SCALE OF NEUTRINO MASSES

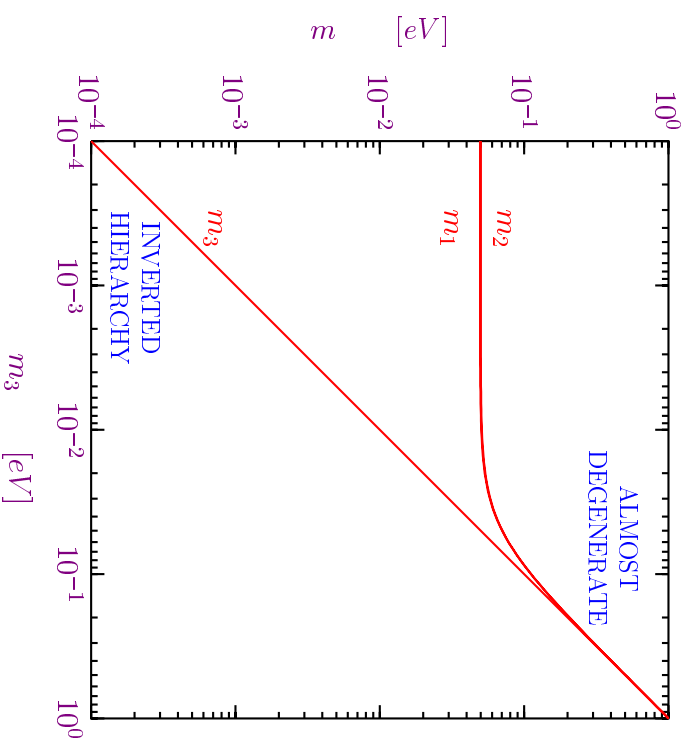
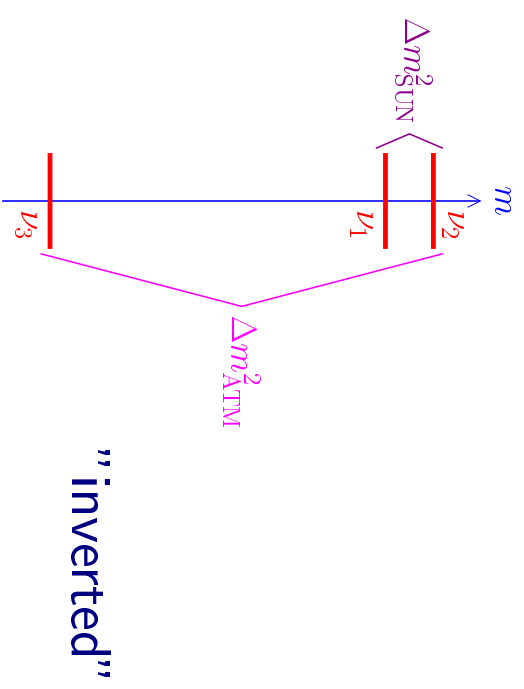
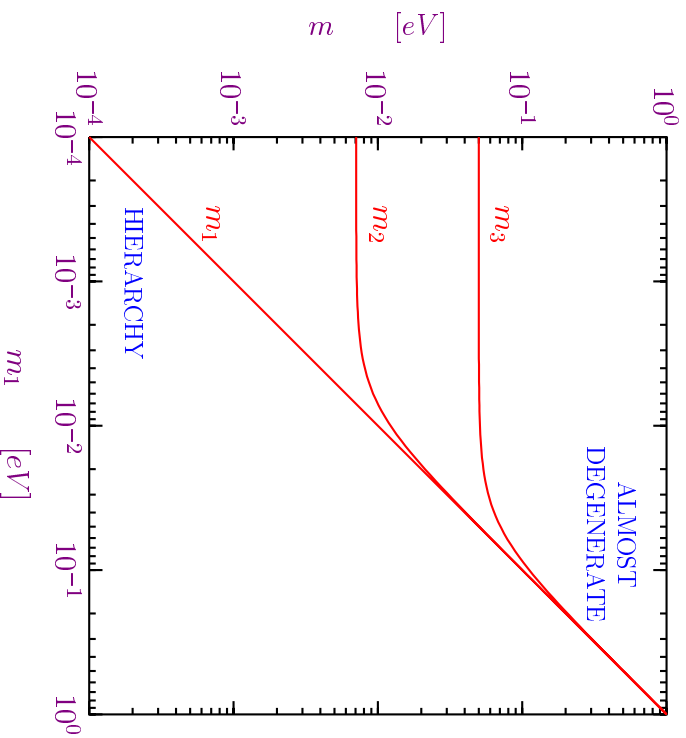
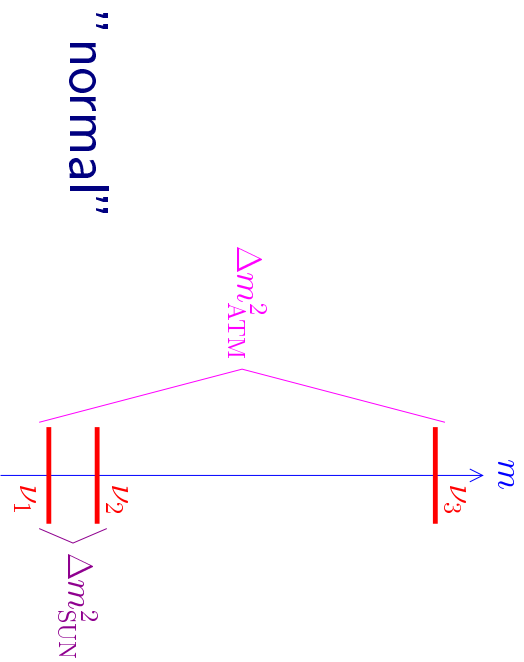

constraints on the main massive components of active flavor ν_e, ν_μ, ν_τ

Tritium β -decay: $m_{\nu_e} \lesssim 2 - 3 \text{ eV}$ (95% CL) [Mainz, Troitsk]

Cosmology: $\sum_{\text{light } \nu} m_\nu \lesssim 2 - 3 \text{ eV}$ (95% CL) [2dFGRS team, astro-ph/0204152]
 [Hannestad, astro-ph/0205223]

Future: KATRIN

[hep-ex/0109033]

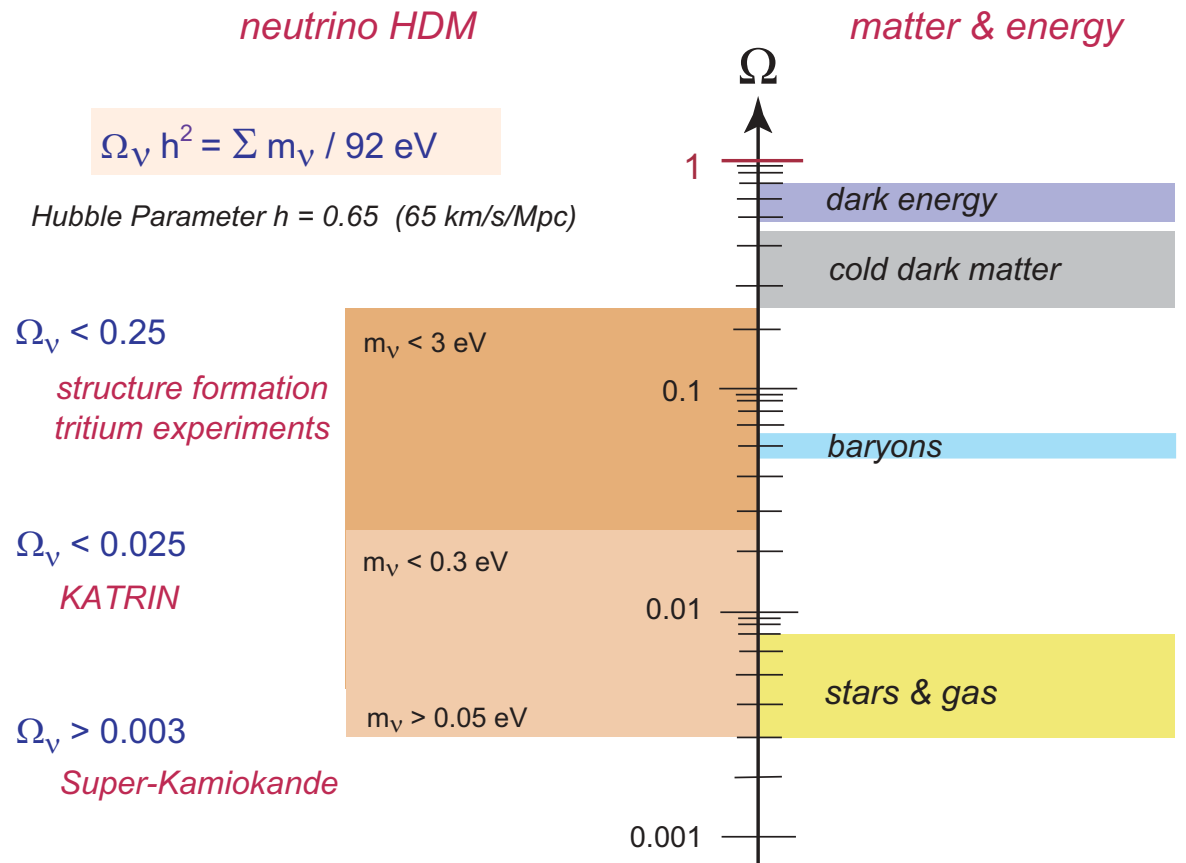

MAJORANA NEUTRINOS? $\iff \beta\beta_{0\nu}$ decay

$$\mathcal{N}(A, Z) \rightarrow \mathcal{N}(A, Z + 2) + e^- + e^-$$

effective Majorana mass $|\langle m \rangle| = \left| \sum_k U_{ek}^2 m_k \right|$

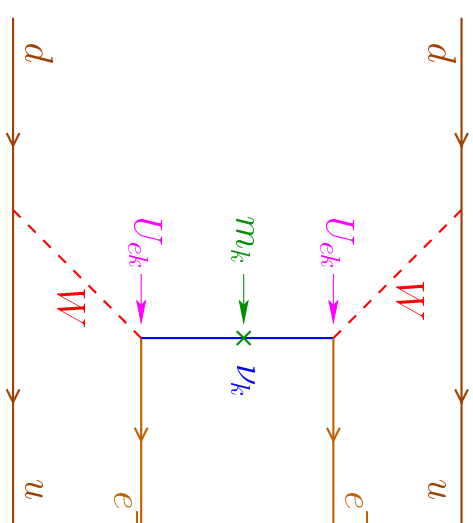

complex $U_{ek} \Rightarrow$ possible cancellations among m_1, m_2, m_3 contributions

$$|\langle m \rangle| = \left| |U_{e1}|^2 m_1 + |U_{e2}|^2 e^{i\alpha_{21}} m_2 + |U_{e3}|^2 e^{i\alpha_{31}} m_3 \right|$$

conserved CP

$$\alpha_{21} = 0, \pi \quad \alpha_{31} = 0, \pi$$

$$\eta_{kj} = e^{i\alpha_{kj}} \quad \text{relative CP parity}$$

Heidelberg-Moscow (^{76}Ge) $|\langle m \rangle|_{\text{exp}} < 0.35 \text{ eV}$ (90% CL)

[EPJA 12 (2001) 147]

AMEX (^{76}Ge) $|\langle m \rangle|_{\text{exp}} < 0.33 - 1.35 \text{ eV}$ (90% CL)

[PRD 65 (2002) 092007]

about factor 3 theoretical uncertainty on nuclear matrix element!

NEUTRINO OSCILLATIONS $\iff \beta\beta_{0\nu}$ decay

$$|\langle m \rangle| = \left| |U_{e1}|^2 m_1 + |U_{e2}|^2 e^{i\alpha_{21}} m_2 + |U_{e3}|^2 e^{i\alpha_{31}} m_3 \right|$$

mass hierarchy without fine-tuned cancellations among

[Giunti, PRD 61 (2000) 036002]

m_2, m_3 contributions

$$|\langle m \rangle| \simeq \max_k |\langle m \rangle|_k \qquad |\langle m \rangle|_k \equiv |U_{ek}|^2 m_k$$

$$|U_{e2}|^2 \simeq \sin^2 \vartheta_{\text{SUN}}, \quad m_2 \simeq \sqrt{\Delta m_{\text{SUN}}^2} \qquad |U_{e3}|^2 \simeq \sin^2 \vartheta_{\text{CHOOZ}}, \quad m_3 \simeq \sqrt{\Delta m_{\text{ATM}}^2}$$

LMA (99.73% CL)

$$0.24 < \tan^2 \vartheta_{\text{SUN}} < 0.89$$

$$2.3 \times 10^{-5} < \Delta m_{\text{SUN}}^2 < 3.7 \times 10^{-4} \qquad \Rightarrow \quad 9 \times 10^{-4} \lesssim |\langle m \rangle|_2 \lesssim 9 \times 10^{-3}$$

[Bahcall, Gonzalez-Garcia, Peña-Garay, hep-ph/0204314]

$$\begin{aligned} |U_{e3}|^2 &\lesssim 4 \times 10^{-2} \\ \Delta m_{\text{ATM}}^2 &\simeq 2.5 \times 10^{-3} \qquad \Rightarrow \quad |\langle m \rangle|_3 \lesssim 2 \times 10^{-3} \end{aligned}$$

m_2 contribution $|\langle m \rangle|_2$ may be dominant! (lower limit for $|\langle m \rangle|$)

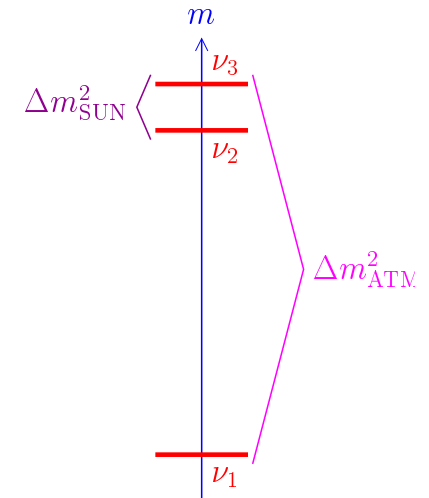
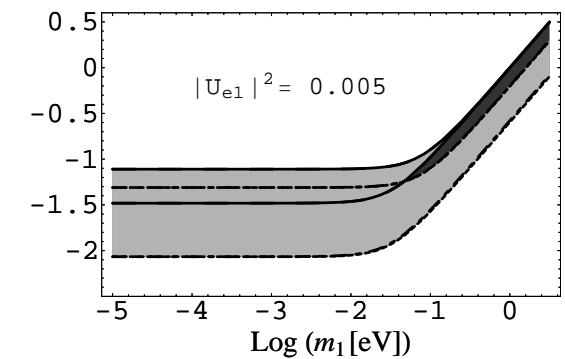
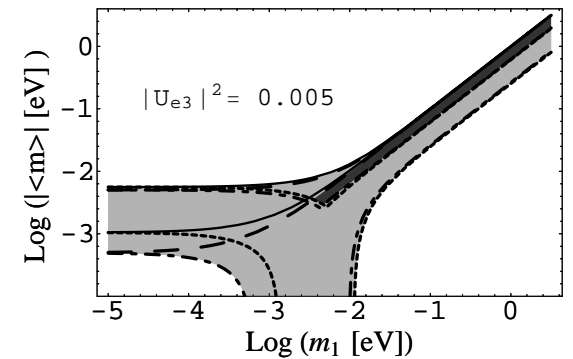
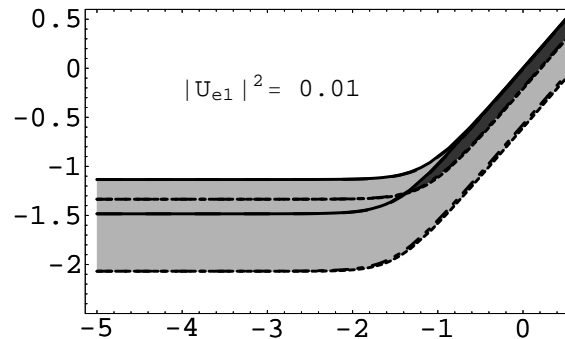
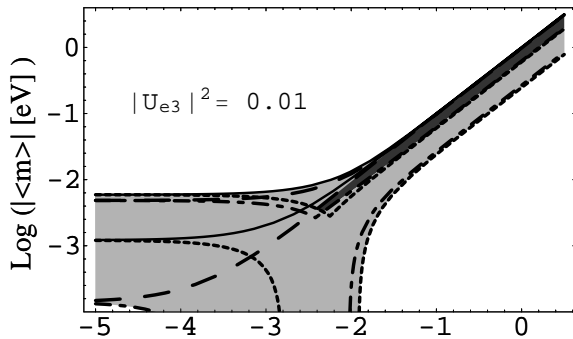
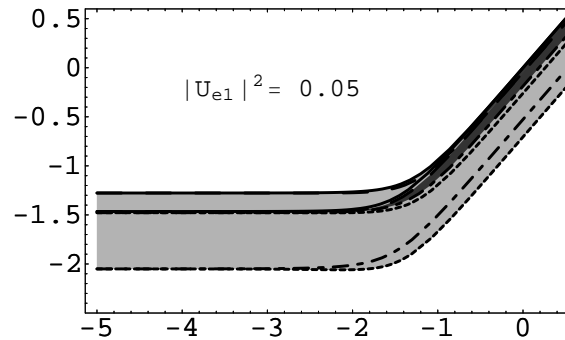
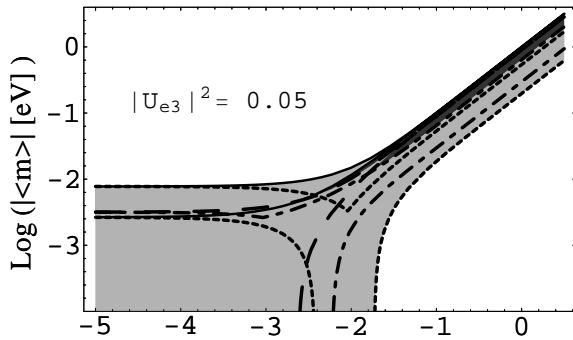
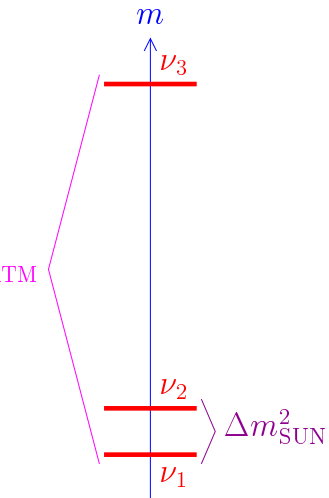

[Pascoli, Petcov, hep-ph/0205022]

see also

[Feruglio, Strumia, Vissani, hep-ph/0201291]

FUTURE: NEMO3, CAMEO, Majorana, CUORICINO, XMASS ($|\langle m \rangle| \sim 10^{-1}$ eV)
 GENIUS, CUORE, EXO, MOON, GEM ($|\langle m \rangle| \sim 10^{-2}$ eV)

LSND $\Rightarrow N_\nu > 3$

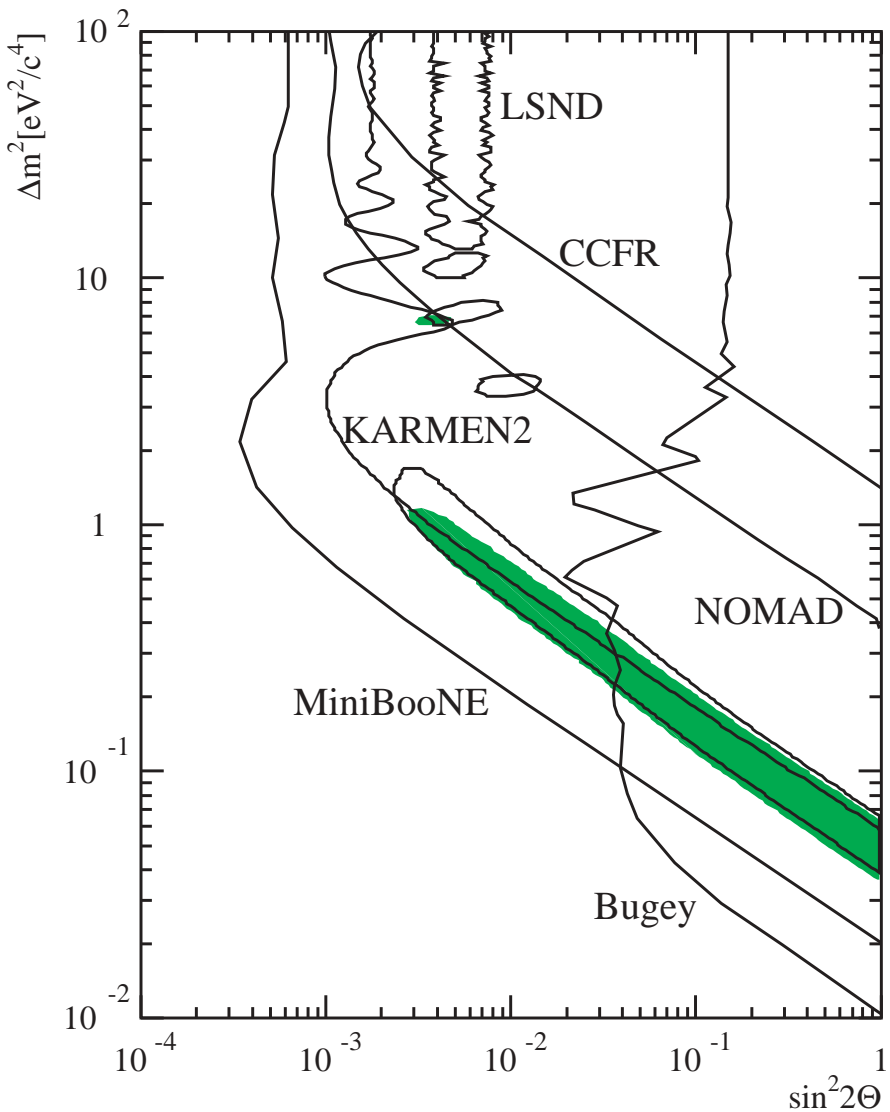

[Church, Eitel, Mills, Steidl, PRD66 (2002) 013001]

$$\Delta m_{\text{LSND}}^2 \sim 0.2 - 1 \text{ eV}^2$$

$$\Delta m_{\text{ATM}}^2 \sim 10^{-3} - 10^{-2} \text{ eV}^2$$

$$\Delta m_{\text{SUN}}^2 \lesssim 10^{-4} \text{ eV}^2$$



$$N_\nu > 3$$

see

[Giunti, hep-ph/0012236]

OKKAM'S RAZOR



$$N_\nu = 4$$



light sterile ν_s

FOUR-NEUTRINO MIXING

$$\Delta m_{\text{LSND}}^2 \sim 1 \text{ eV}^2$$

$$\Delta m_{\text{ATM}}^2 \sim 3 \times 10^{-3} \text{ eV}^2$$

$$\Delta m_{\text{SUN}}^2 \lesssim 10^{-4} \text{ eV}^2$$

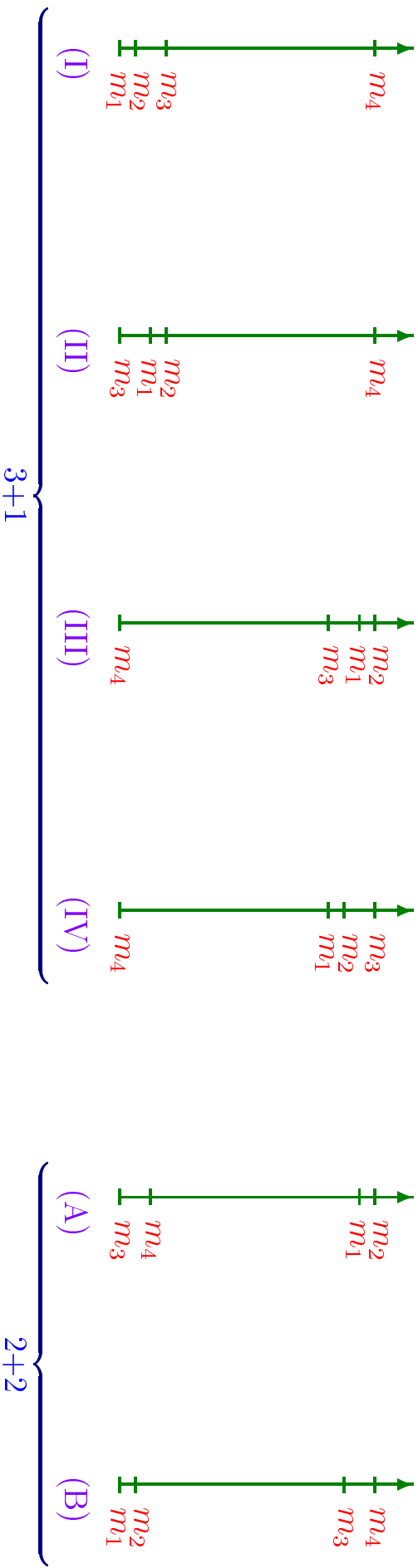

3+1 schemes disfavored by short-baseline ν oscillation experiments

[Bilenky, Giunti, Grimus, EPJC 1 (1998) 247]

[Bilenky, Giunti, Grimus, Schwetz, PRD 60 (1999) 073007]

2+2 schemes need ν_s in SUN or ATM ($\eta_s^{\text{SUN}} + \eta_s^{\text{ATM}} \simeq 1$)

[Peres, Smirnov, NPB 599 (2001) 3]

2+2 FOUR-NEUTRINO SCHEMES

pure $\nu_\mu \rightarrow \nu_s$ is strongly disfavored in ATM (SK)

pure $\nu_e \rightarrow \nu_s$ is practically excluded in SUN (SNO & SNO+SK)

partial $\nu_e \rightarrow \nu_s$ in SUN and $\nu_\mu \rightarrow \nu_s$ in ATM is disfavored

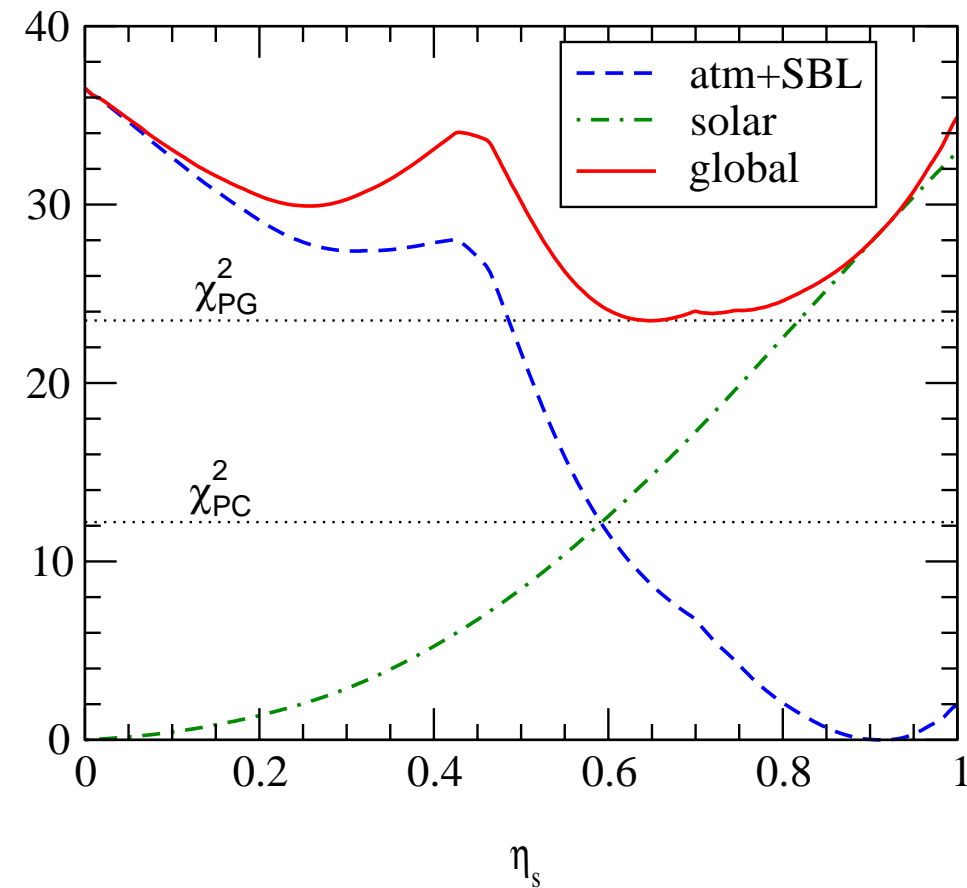

$\eta_S \equiv$ fraction of ν_s in solar osc.

$$\text{G.o.F.} = 1.3 \times 10^{-6}$$

[Maltoni, Schwetz, Tortóla, Valle, hep-ph/0207157]

see also

[Dooling, Giunti, Kim, Kang, PRD 61 (2000) 073011]

[Giunti, Gonzalez-Garcia, Peña-Garay, PRD 62 (2000) 013005]

[Yasuda, hep-ph/0006319]

[Fogli, Lisi, Marrone, PRD 63 (2001) 053008]

[Gonzalez-Garcia, Maltoni, Peña-Garay, PRD 64 (2001) 093001]

[Bahcall, Gonzalez-Garcia, Peña-Garay, hep-ph/0204194]

[Maltoni, Schwetz, Tortóla, Valle, hep-ph/0207227]

3+1 FOUR-NEUTRINO SCHEMES

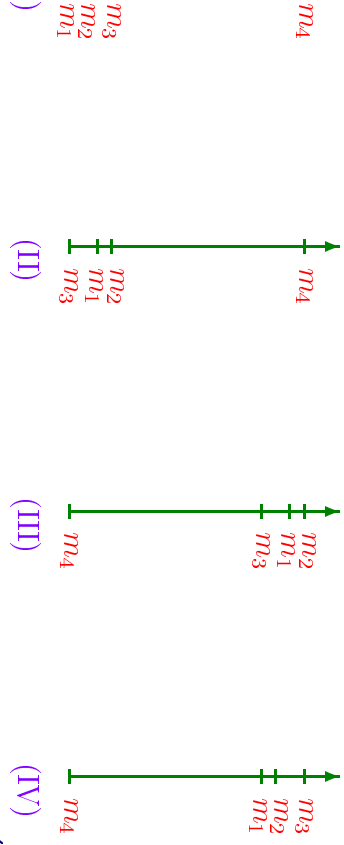

short-baseline experiments

$$A(\nu_e \rightarrow \nu_e) = 4|U_{e4}|^2 (1 - |U_{e4}|^2)$$

$$A(\nu_\mu \rightarrow \nu_\mu) = 4|U_{\mu4}|^2 (1 - |U_{\mu4}|^2)$$

$$A(\nu_\mu \rightarrow \nu_e) = 4|U_{\mu4}|^2 |U_{e4}|^2$$

[Bilenky, Giunti, Grimus, EPJC 1 (1998) 247]

see also

[Barger, Weiler, Whisnant, PLB 427 (1998) 97]

[Barger, Pakvasa, Weiler, Whisnant, PRD 58 (1998) 093016]

[Bilenky, Giunti, Grimus, PPNP 43 (1999) 1]

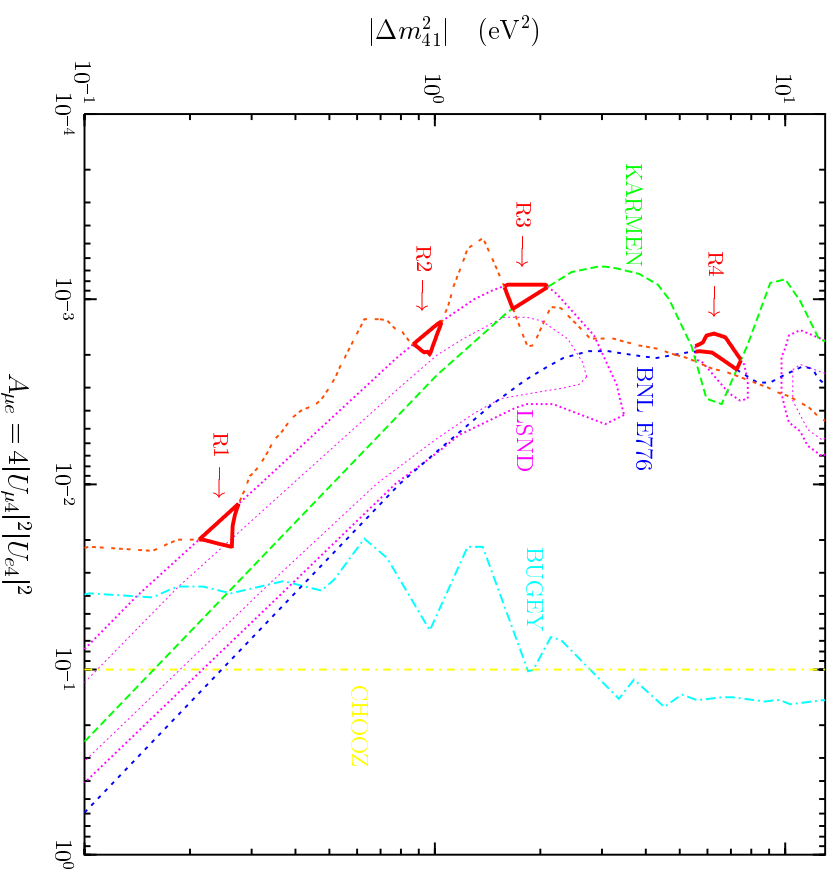

[Giunti, Laveder, JHEP 02 (2001) 001]

see also

[Barger, Kayser, Learned, Weiler, Whisnant, PLB 489 (2000) 345]

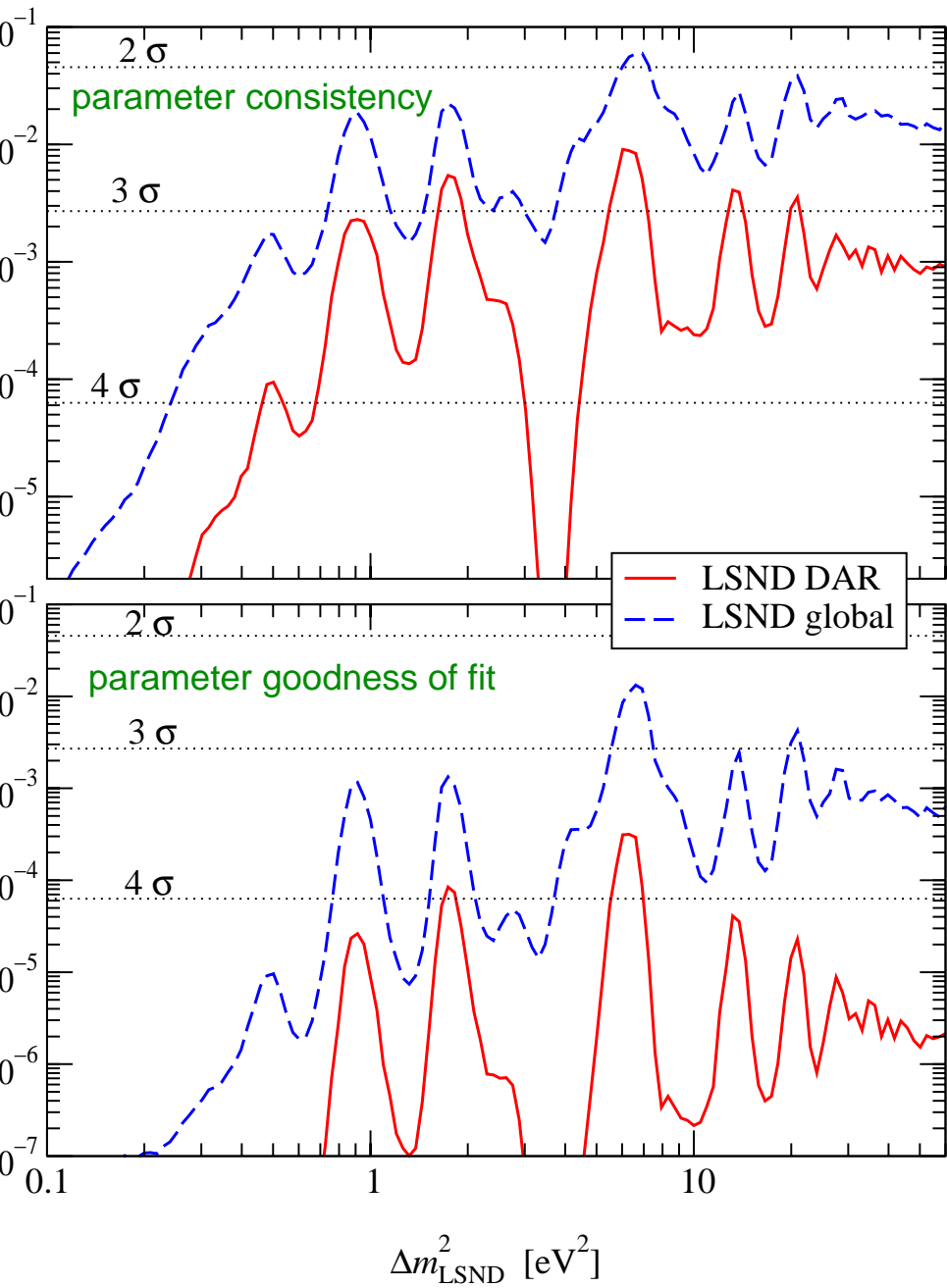

[Maltoni, Schwetz, Tortóla, Valle, hep-ph/0207157]

see also

[Peres, Smirnov, NPB 599 (2001) 3]

[Grimus, Schwetz, EPJC 20 (2001) 1]

[Maltoni, Schwetz, Valle, PLB 518 (2001) 252]

[Maltoni, Schwetz, Valle, PRD 65 (2002) 093004]

[Strumia, PLB 539 (2002) 91]

CONCLUSIONS

SNO and SNO+SK smoking gun evidence of solar flavor transitions

all solar ν experiments \Rightarrow LMA $\nu_e \rightarrow \nu_\mu, \nu_\tau$ transitions

3ν mixing (SUN+ATM) \Rightarrow almost bimaximal mixing with $|U_{e3}|^2 \ll 1$

theory: why $|U_{e3}|^2$ is so small?

future exp.: measure $|U_{e3}| > 0 \Rightarrow$ sign of Δm_{31}^2 and CP violation

4ν mixing is disfavored

SBL experiments disfavor 3+1 schemes

SUN+ATM experiments disfavor 2+2 schemes

adding more sterile neutrinos (e.g. extra-dim.) does not help!

if MiniBooNE will confirm LSND \Rightarrow real puzzle

Neutrino Unbound

<http://www.to.infn.it/~giunti/NU>

Carlo Giunti & Marco Laveder