

Electronic chain for dish test (March 2012)

irfu
cea
saclay

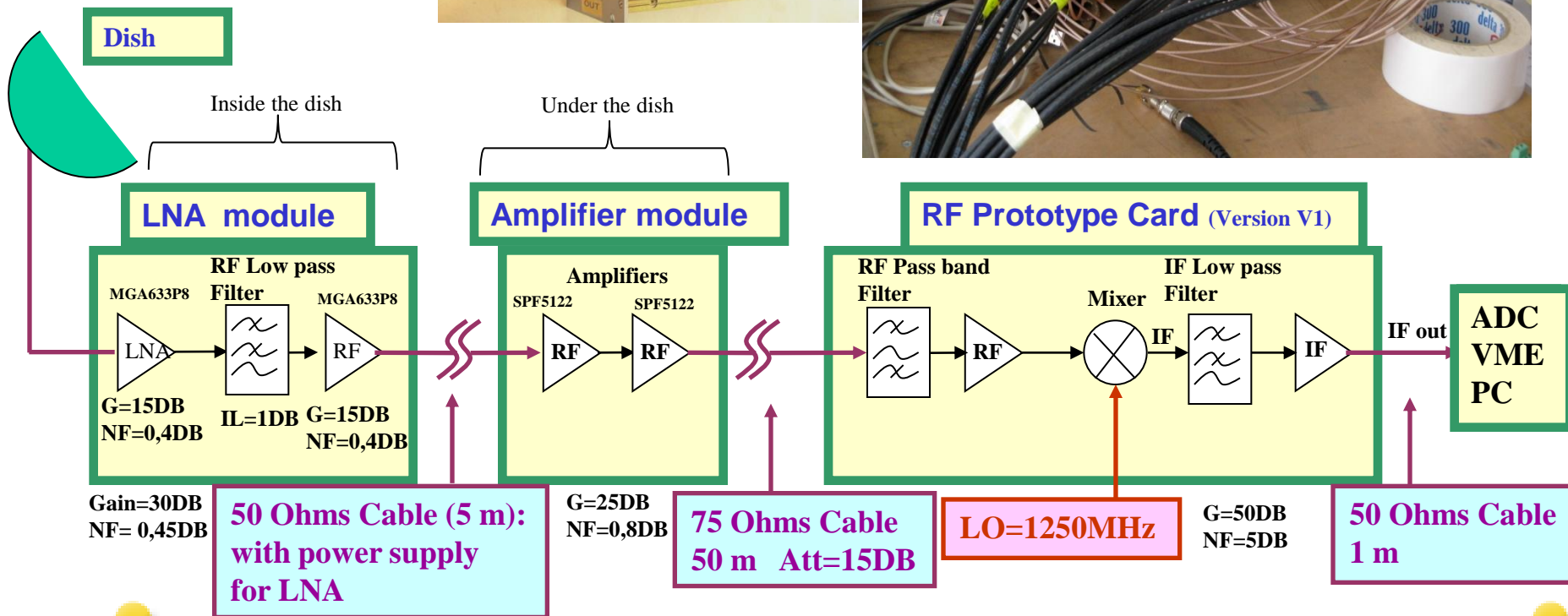
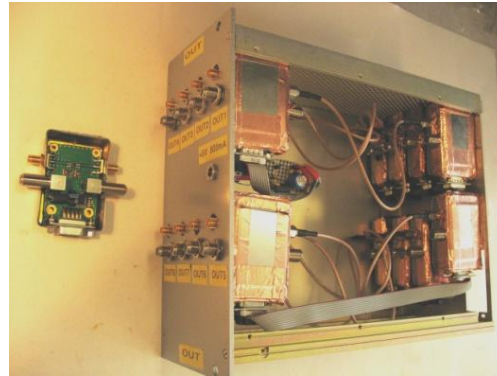

Electronic chain for dish test (March 2011) : LNA Measurement

MGA633P8

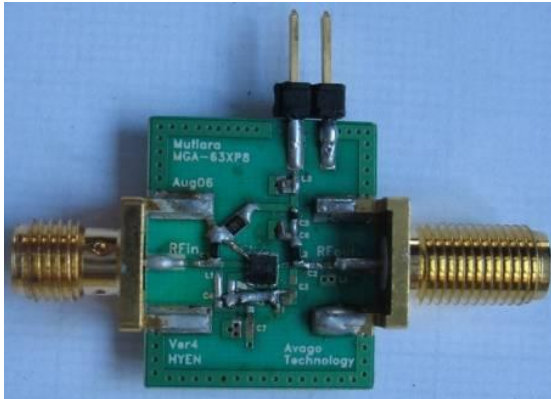

SPF5122

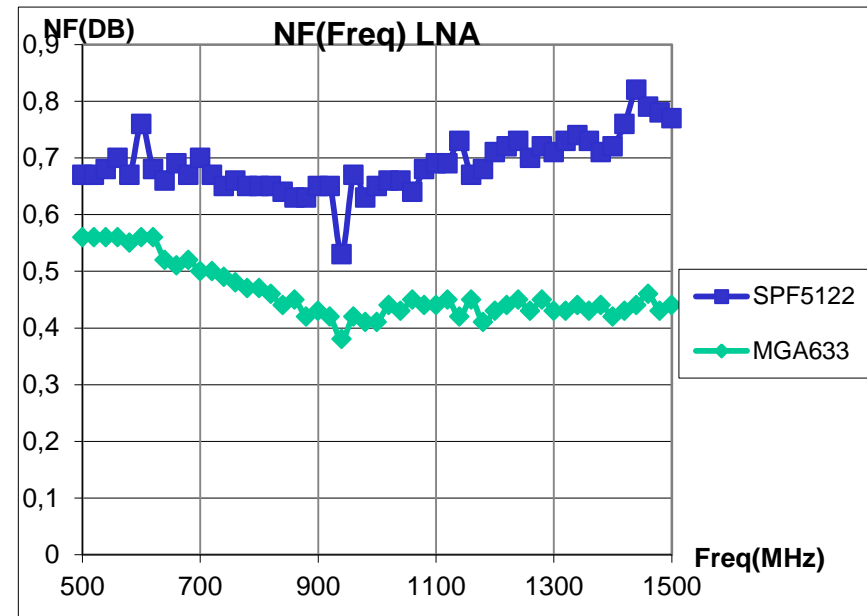
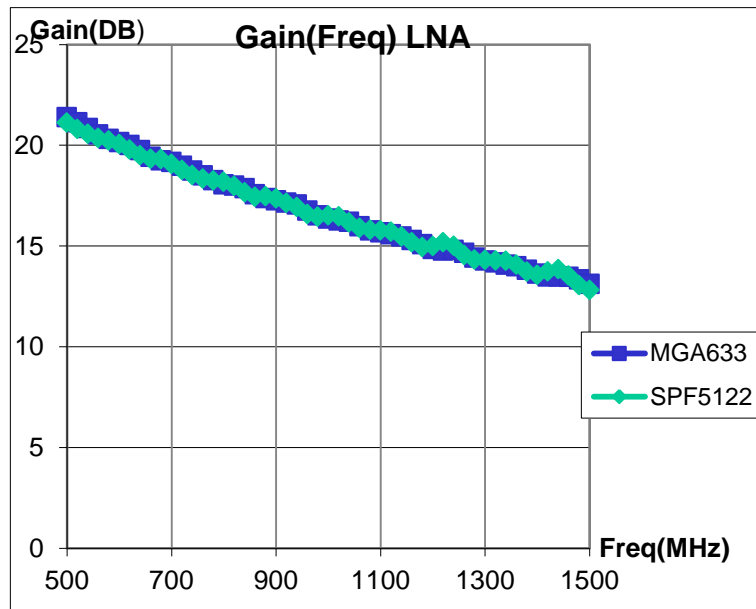
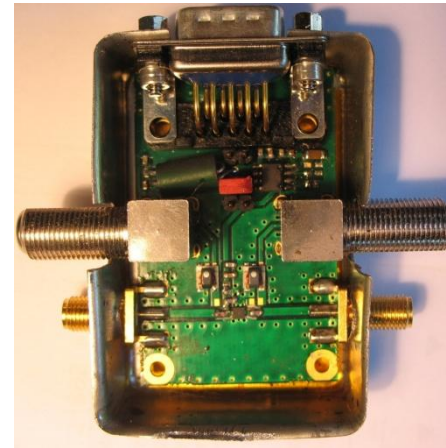

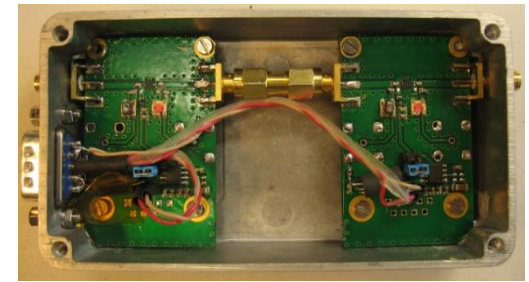
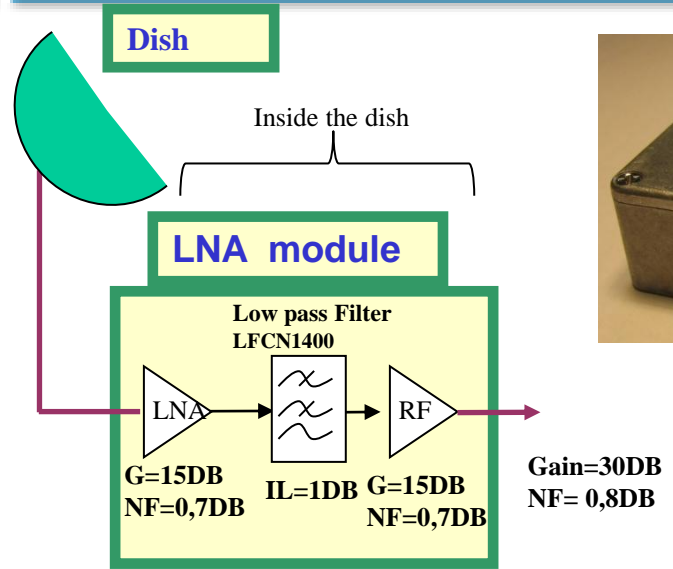

SPF5220

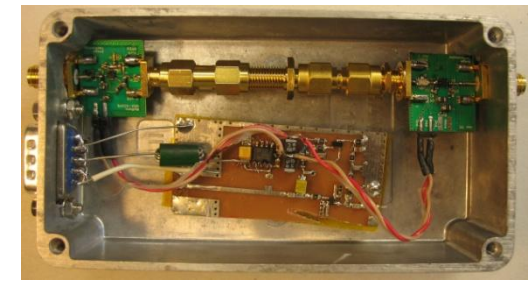

MGA633-P8

Gain(F) LNA_Parabole

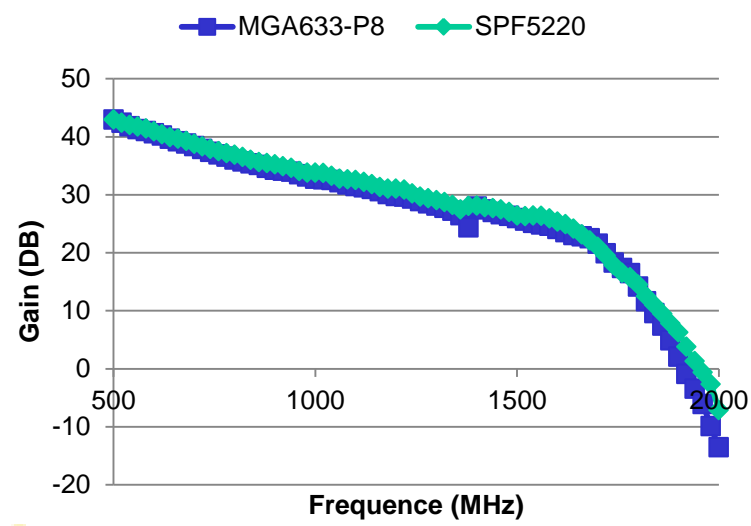

NF(F) LNA_Parabole

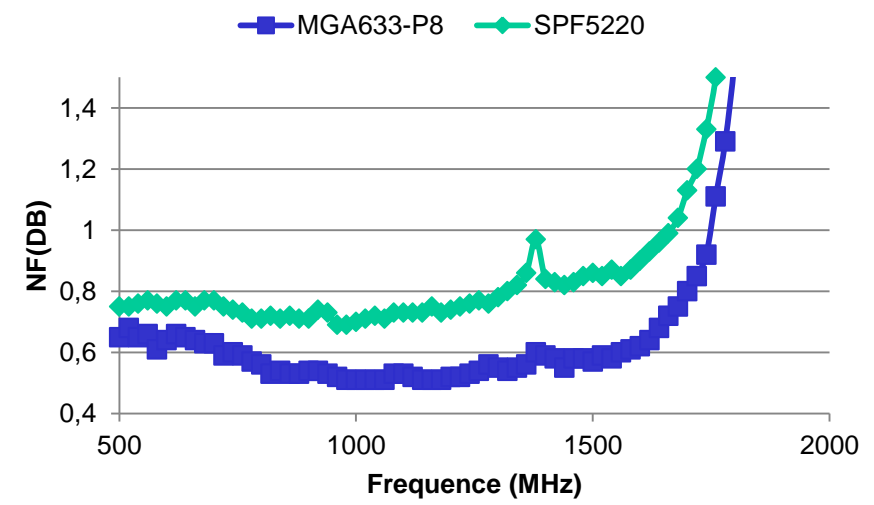

Electronic chain for dish test (March 2012) : 75 ohms Amplifier card

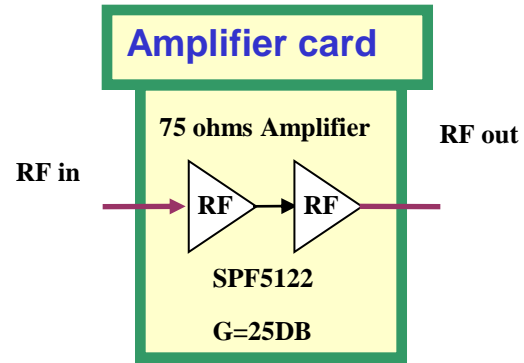
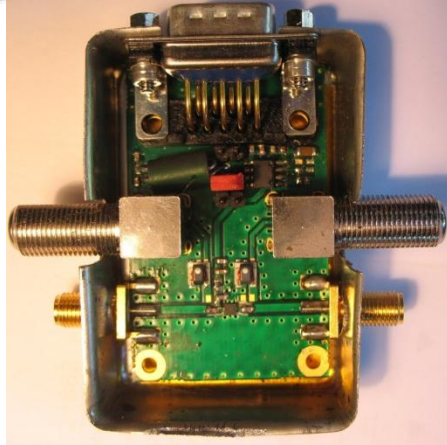

8 channels

Gain (Freq)

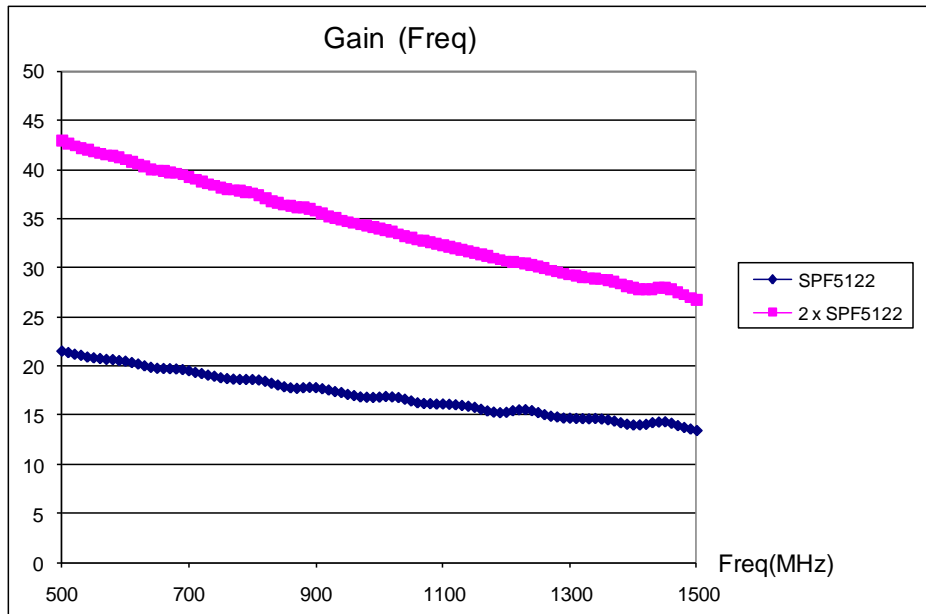

NF (Freq)

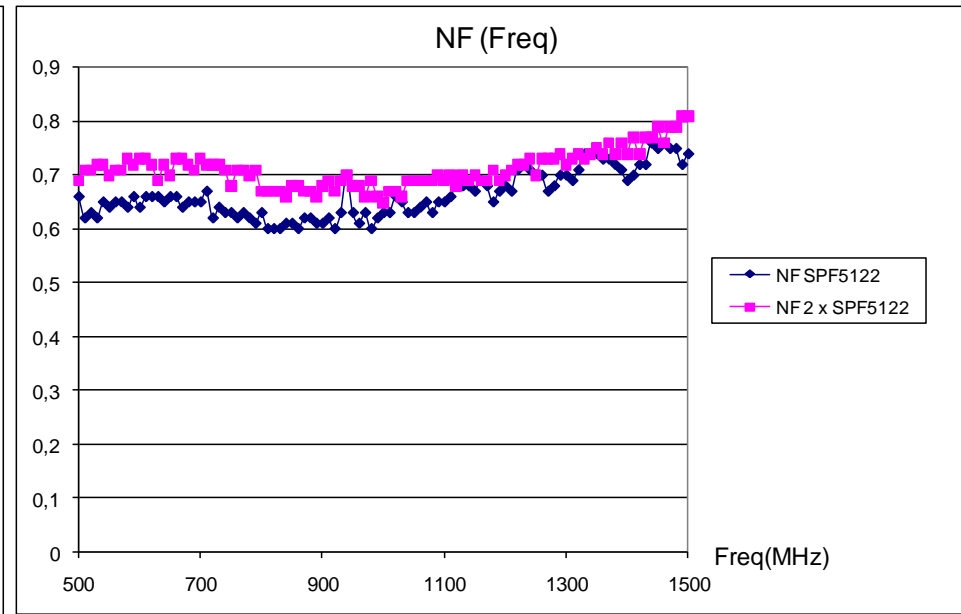

Electronic chain for dish test (March 2012) : mixer prototype card

irfu
cea
saclay

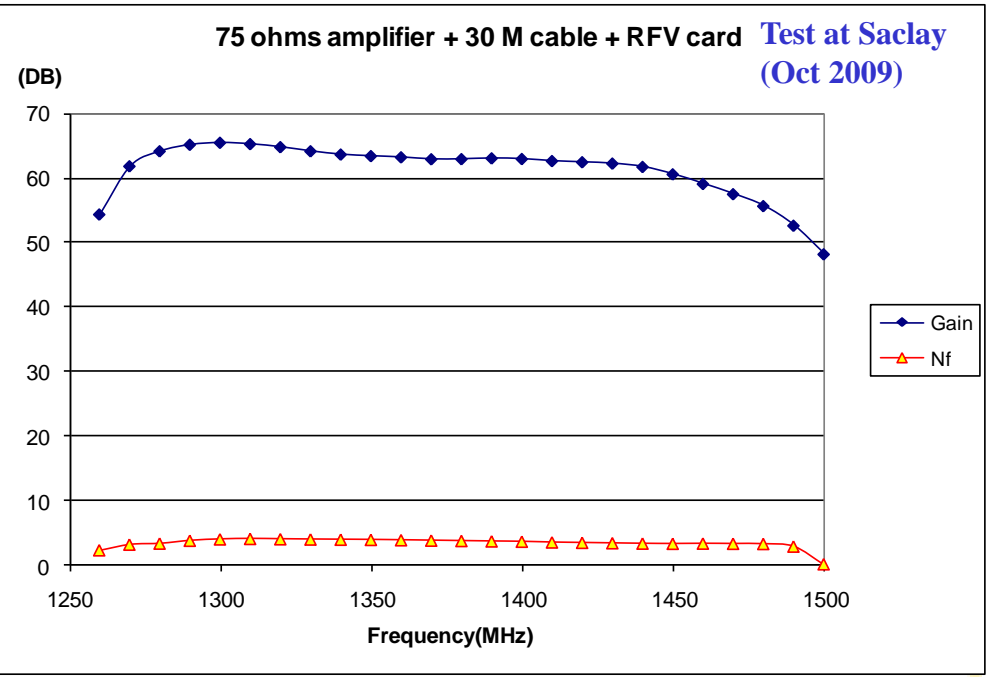
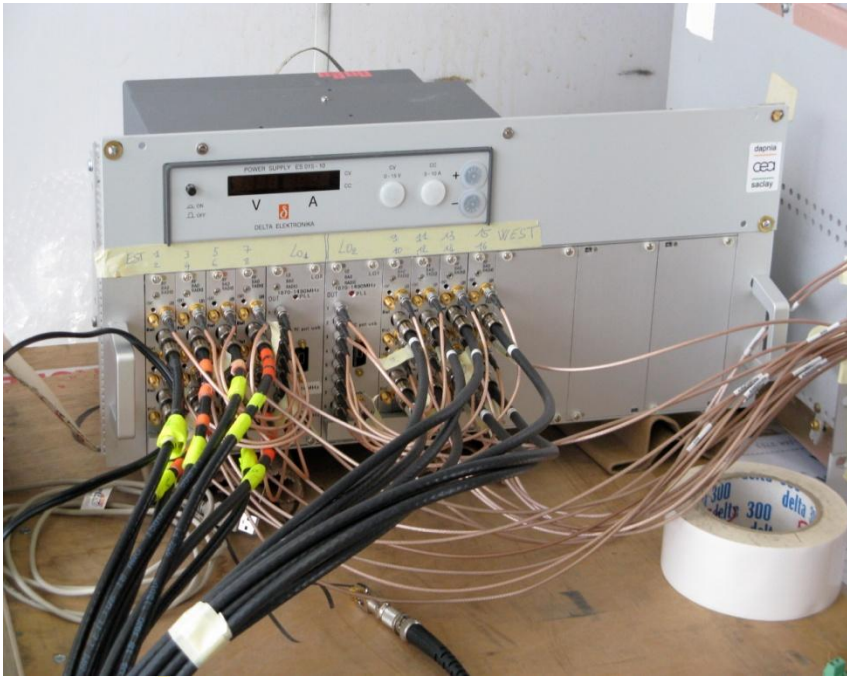
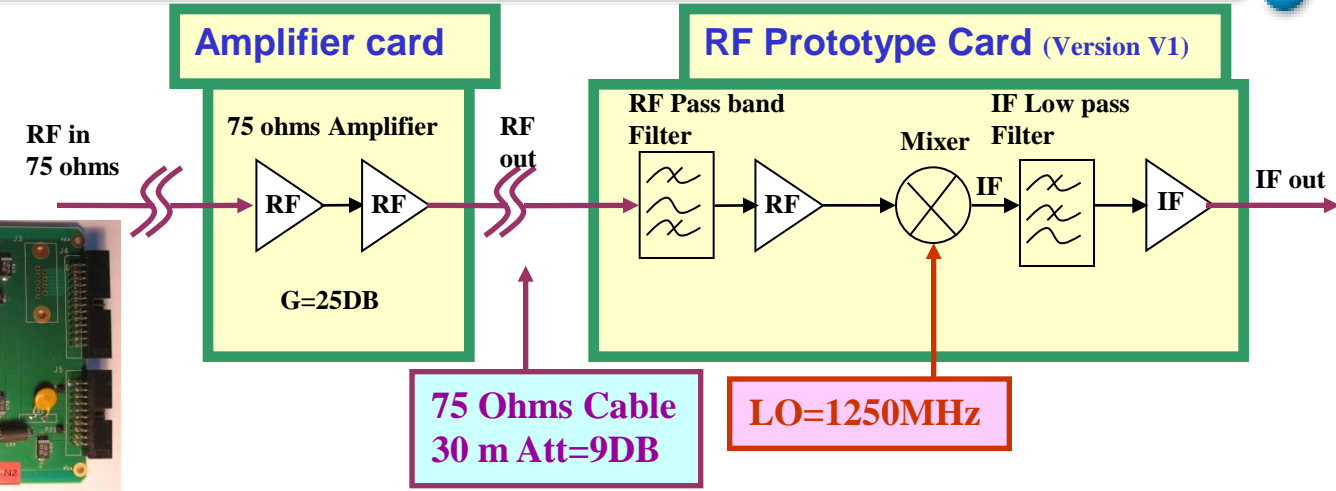
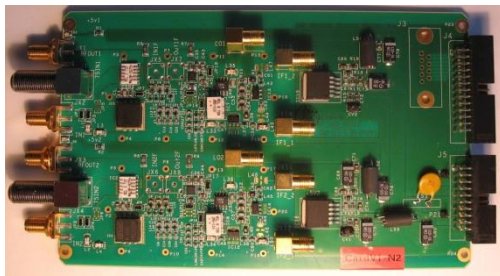

Electronic chain for dish test (June 2012): Cables and power supplies

irfu
cea
saclay

